

Termik

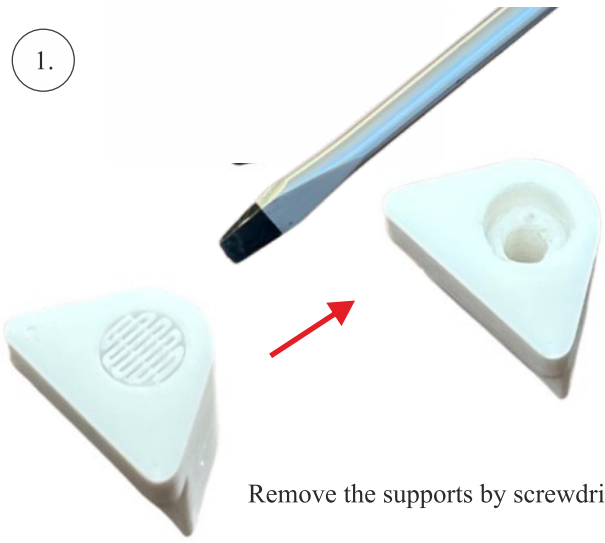

1.



Remove the supports by screwdriver

2.

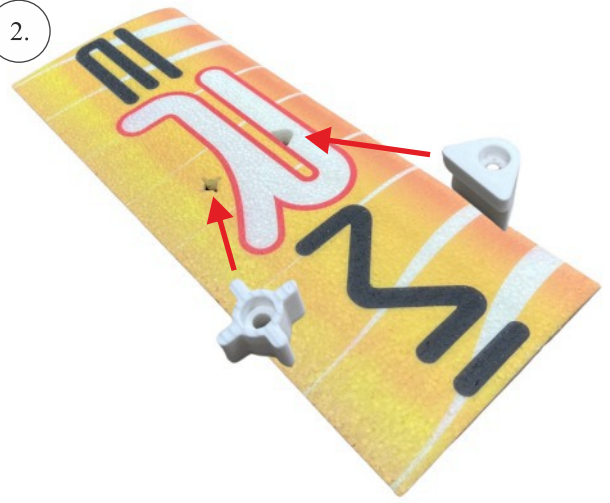

3.

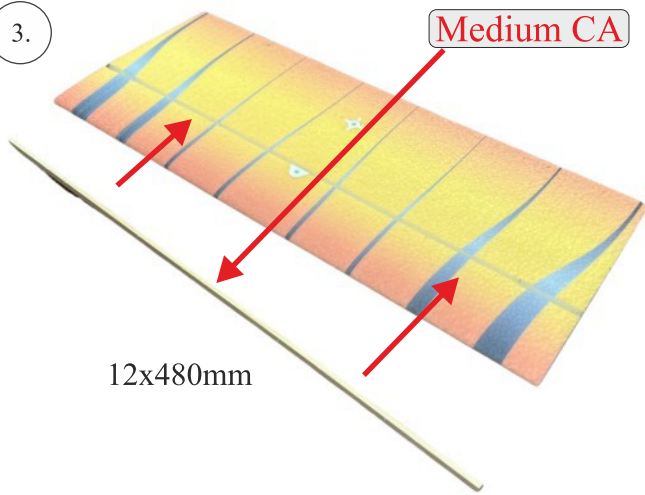

12x480mm

4.

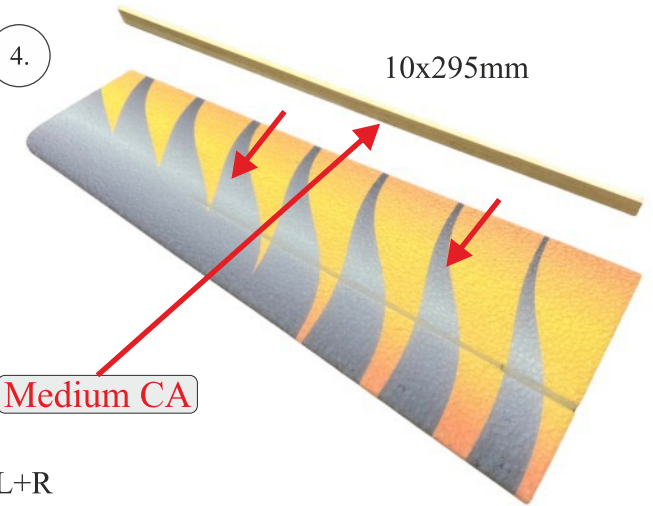

10x295mm

Medium CA

L+R

5.

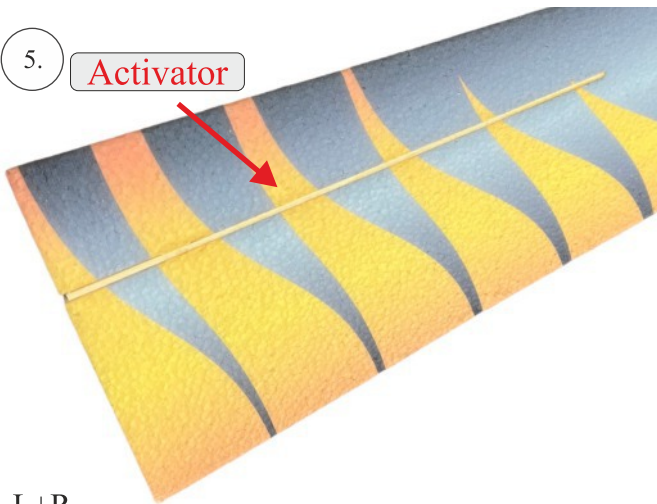

Activator

L+R

6.



prepared for the foil covering

7.

use covering film 38 mic with iron on 145°C



8.



9.

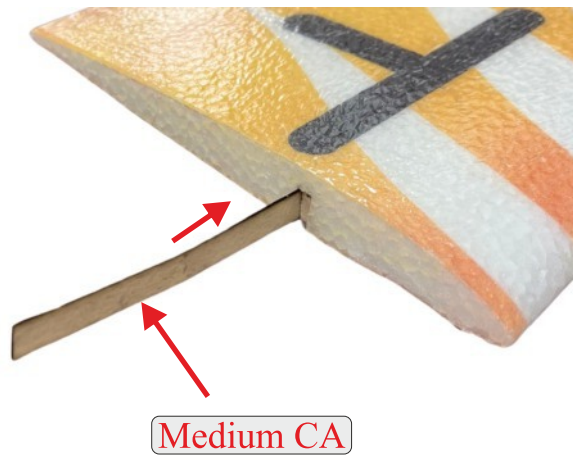

10.

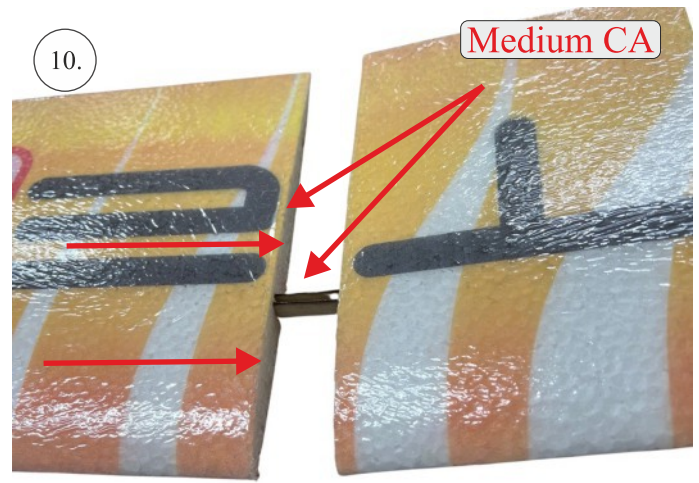

11.



12.

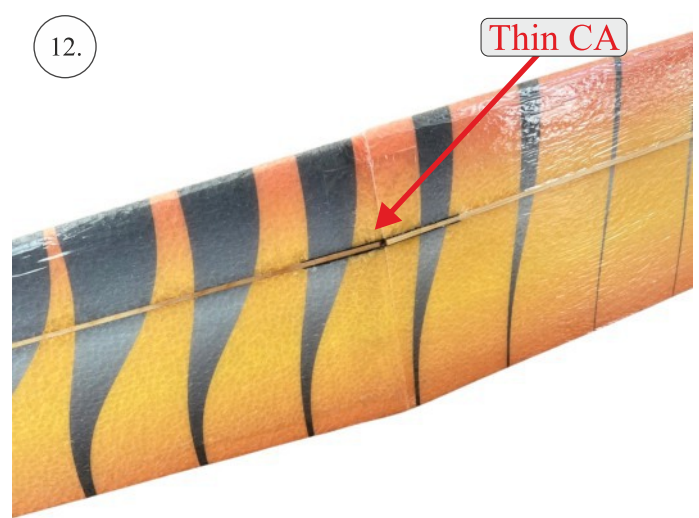

13.

you can cover the join by foil



14.

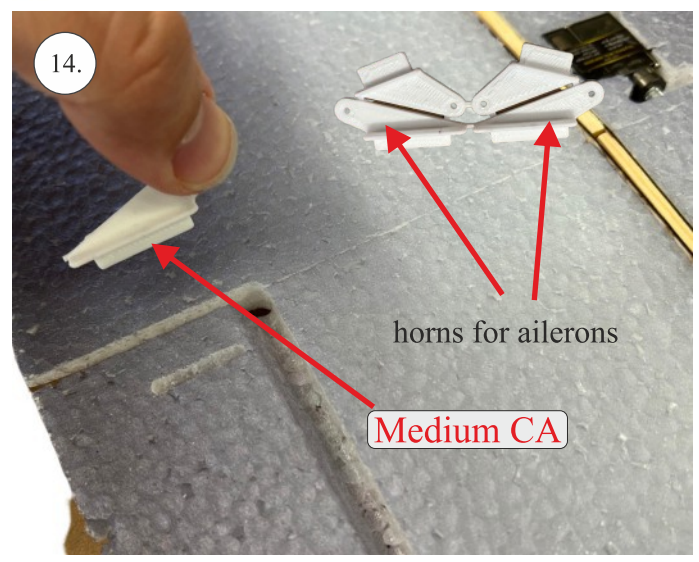

15.

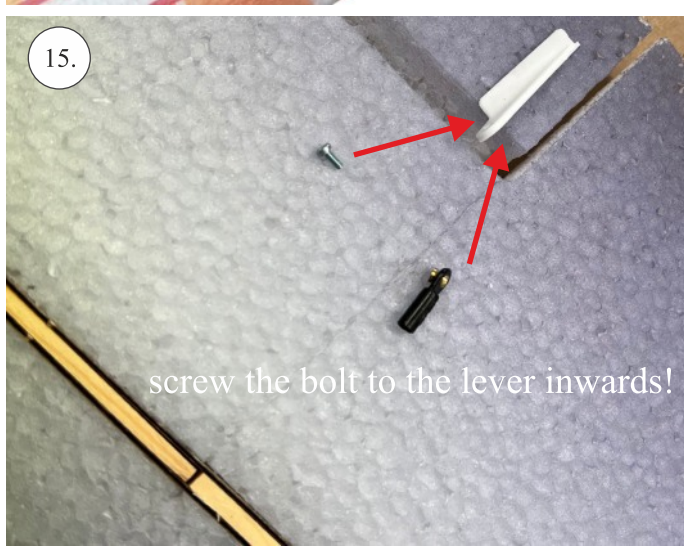

16.

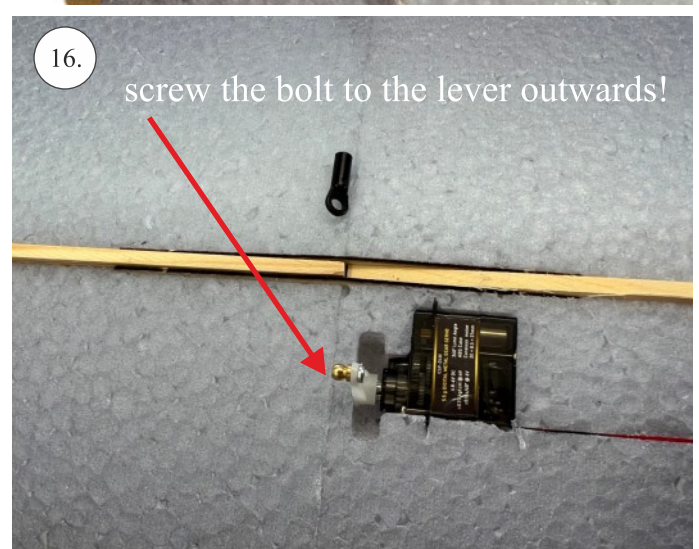

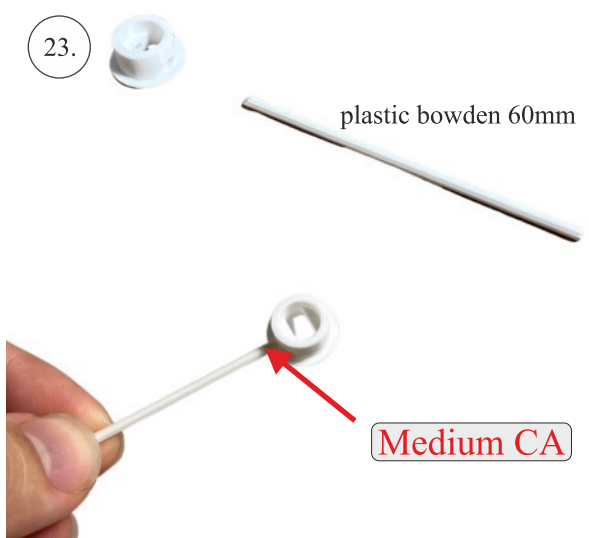
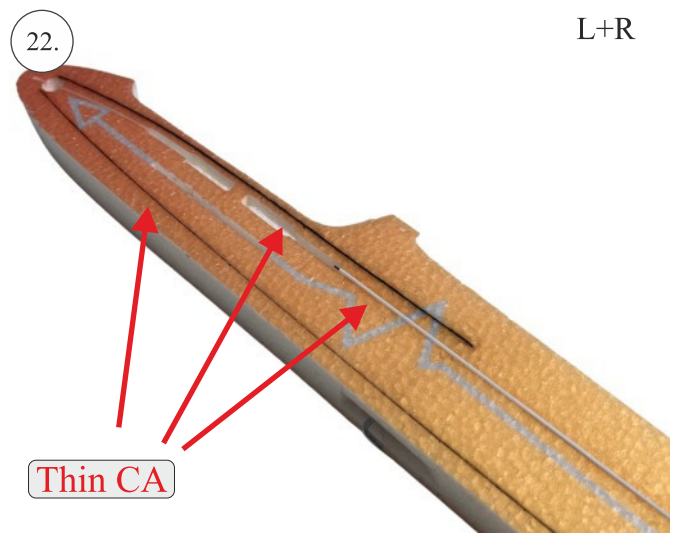
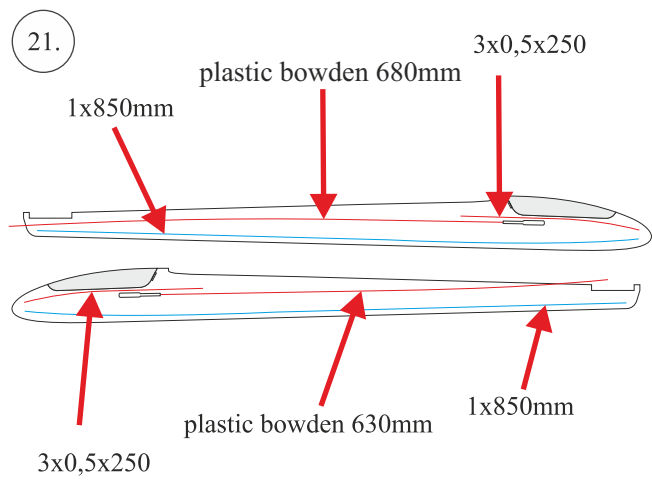
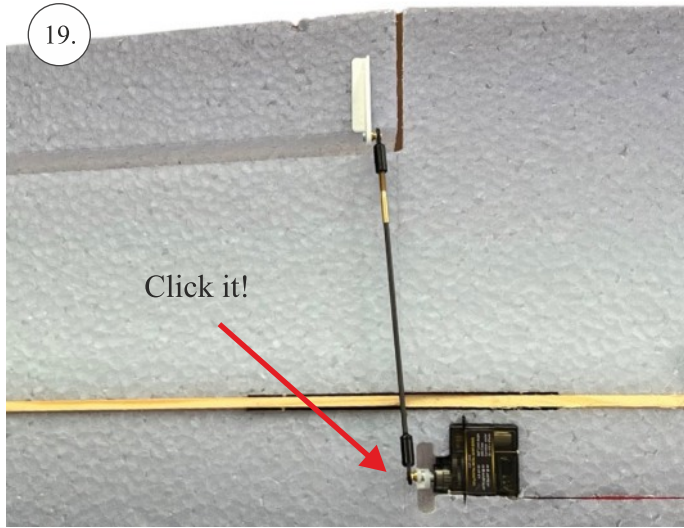
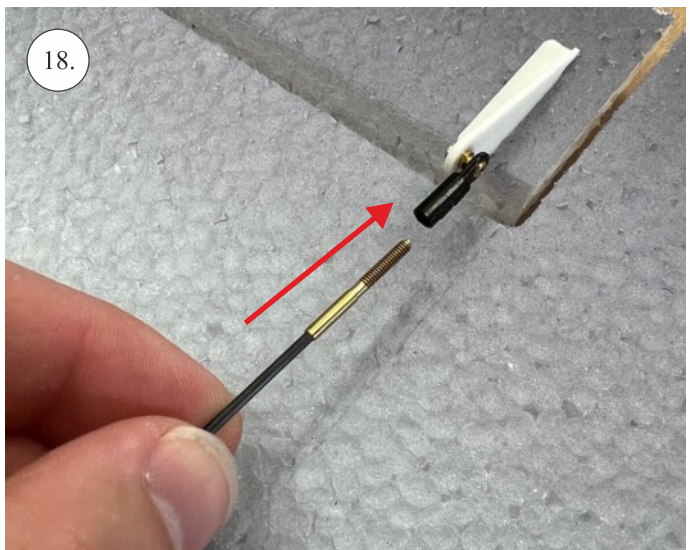

24.

Thin CA

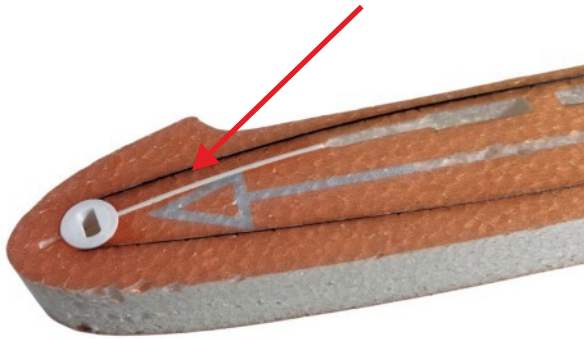

25.

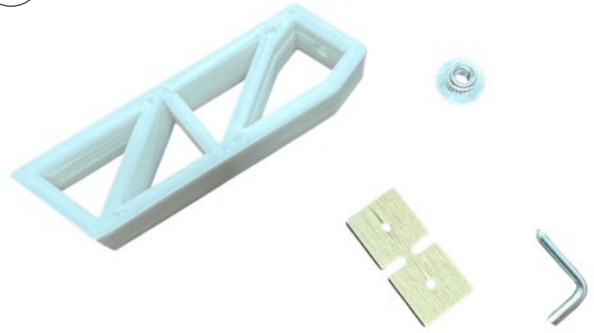

26.

Medium CA

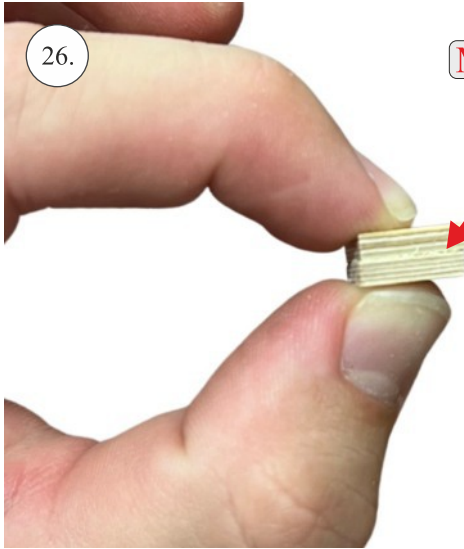

27.

Medium CA

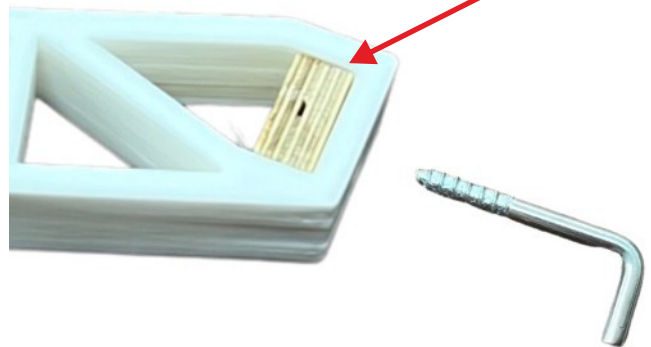

28.

use pliers for the 4mm nut

Medium CA

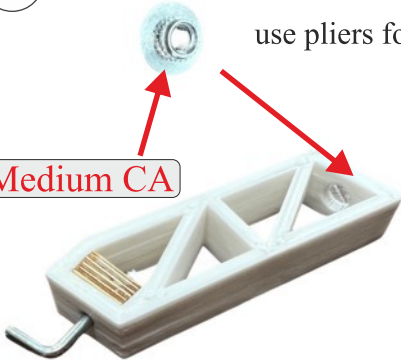

29.



30.

Medium CA

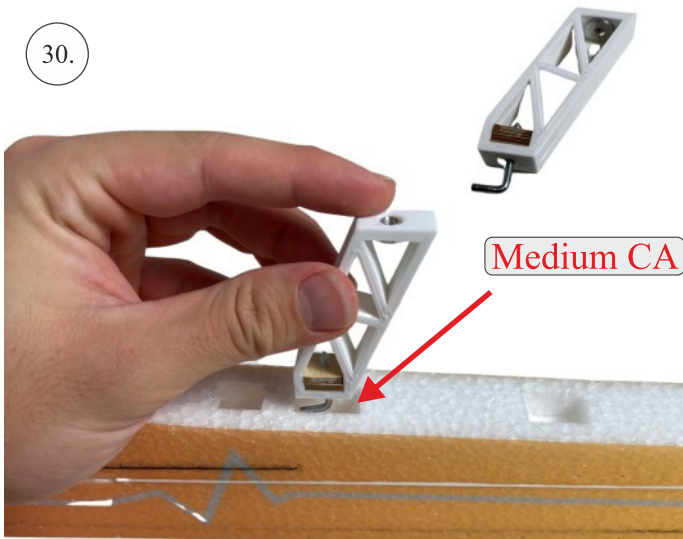

31.

be careful whether it is in the same line



32.

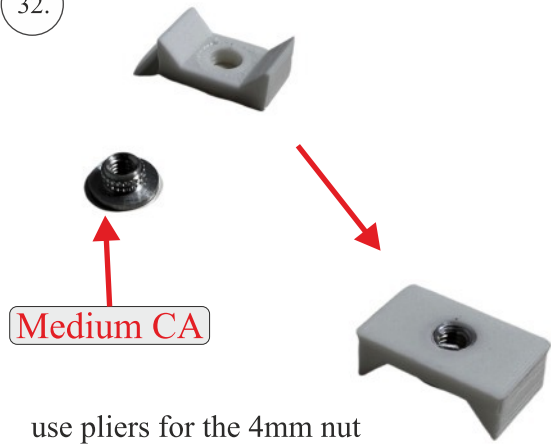

Medium CA

use pliers for the 4mm nut

33.

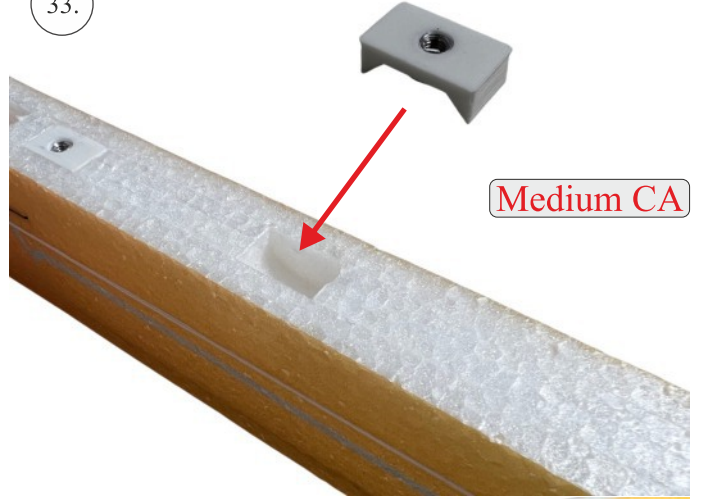

Medium CA

34.

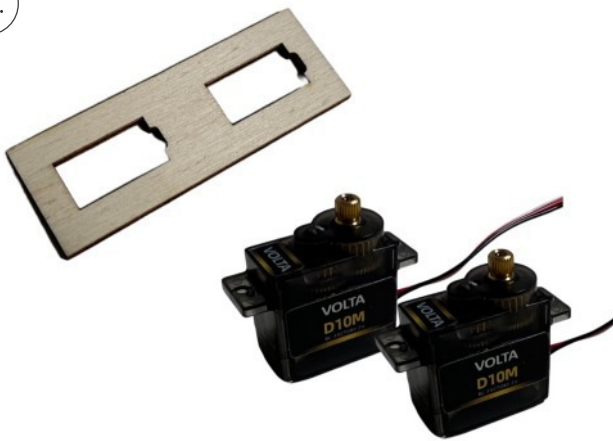

35.

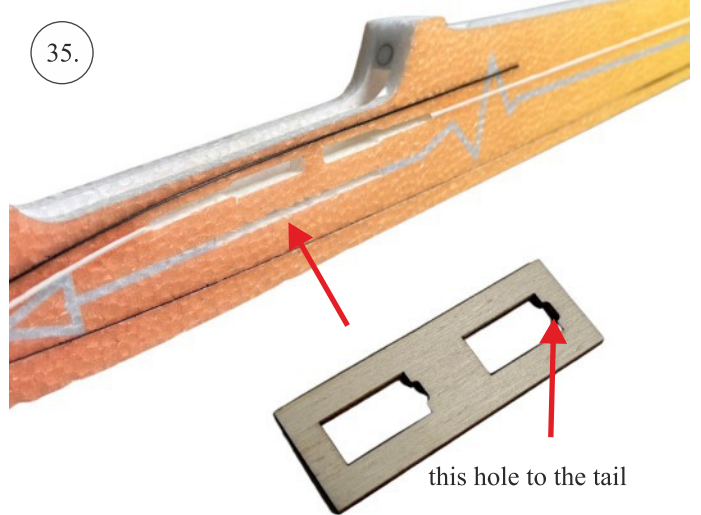

this hole to the tail

36.

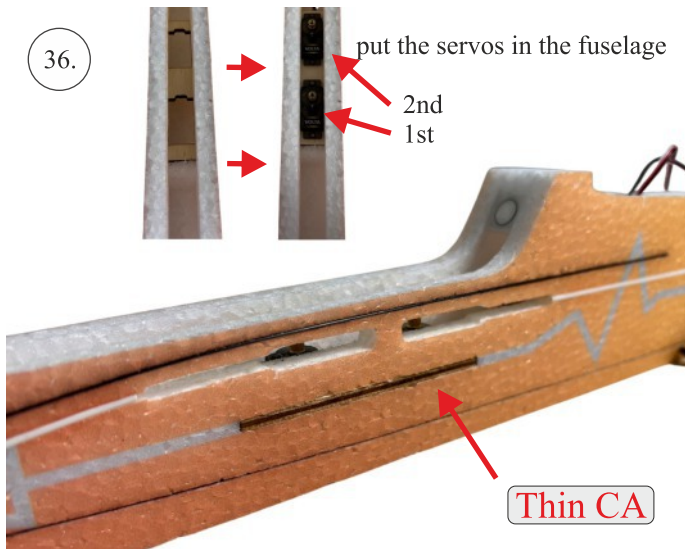

put the servos in the fuselage

2nd
1st

Thin CA

37.



all parts are ready for foil ironing

38.

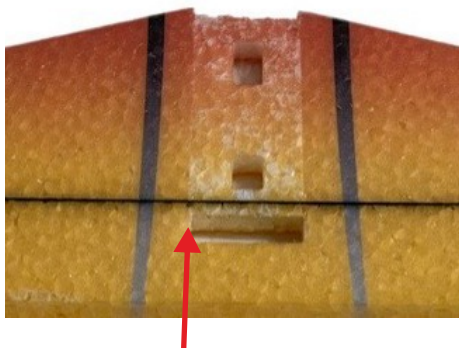

do not leave the places that will be glued covered with foil

39.

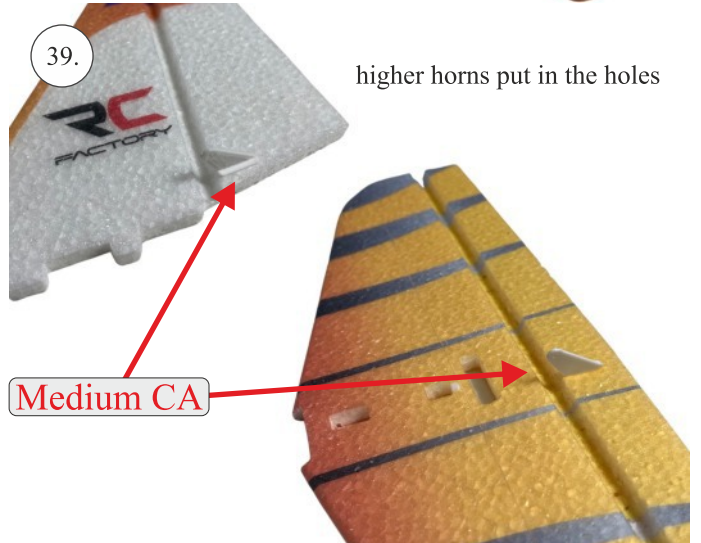

higher horns put in the holes

Medium CA

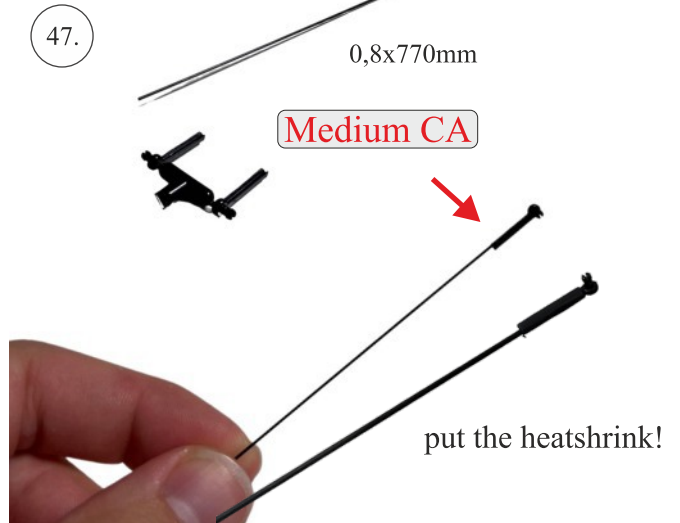
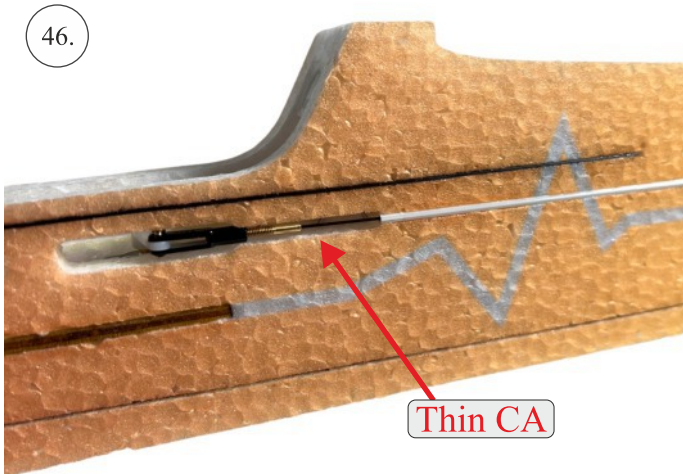
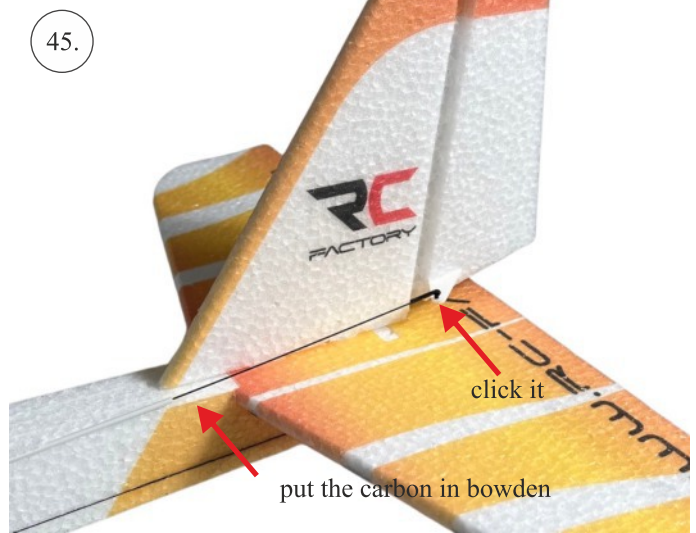
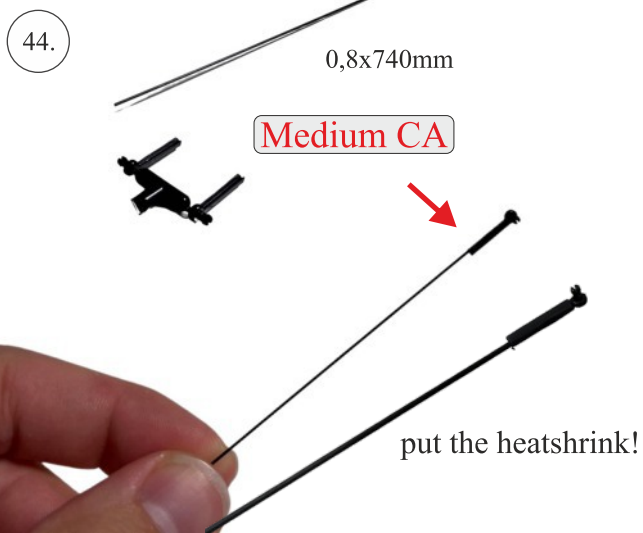
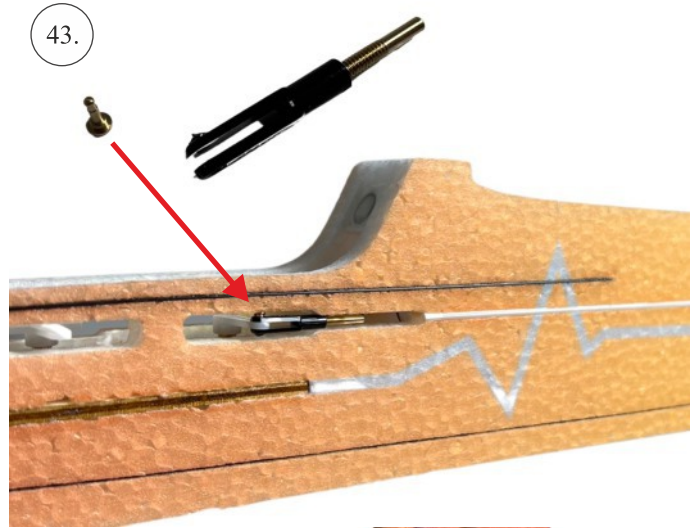
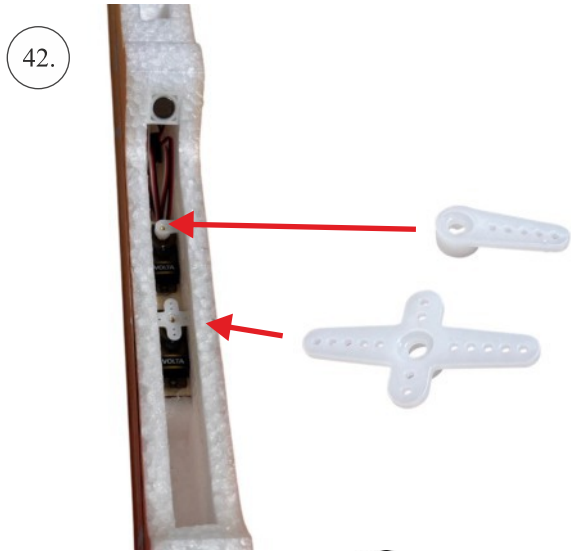
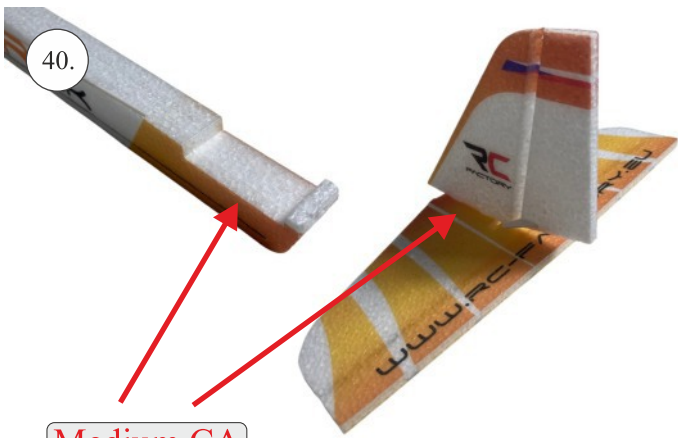

48.

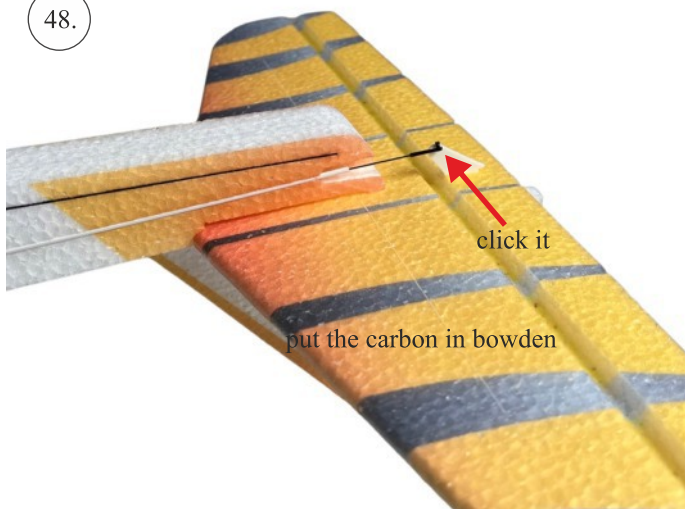

49.

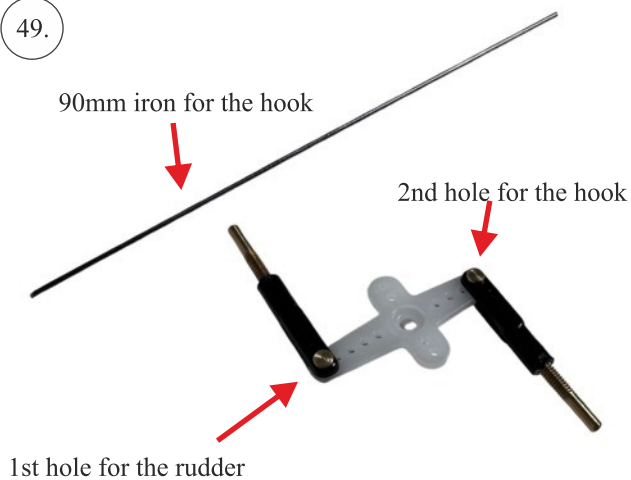

50.

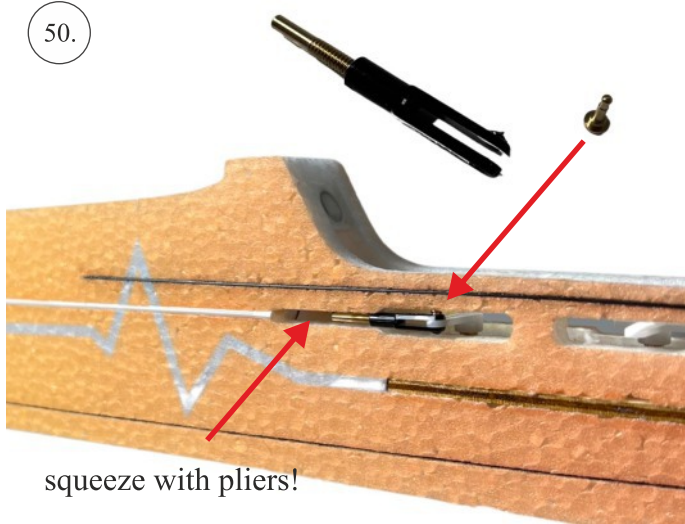

51.

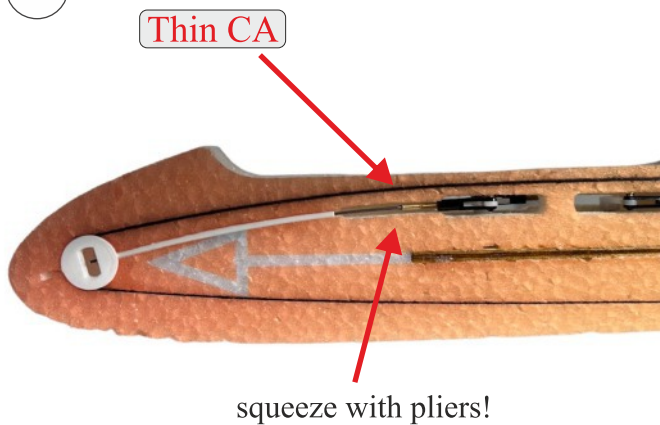

52.



53.



54.

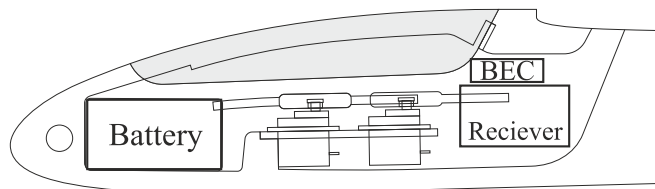
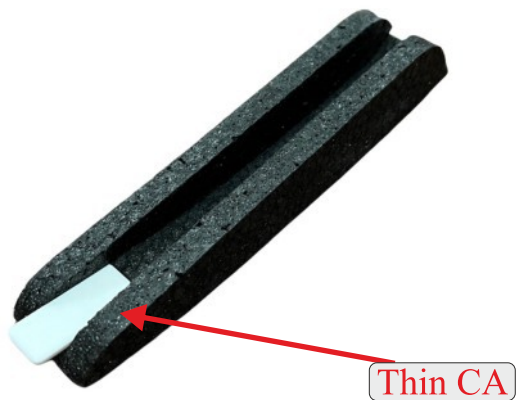

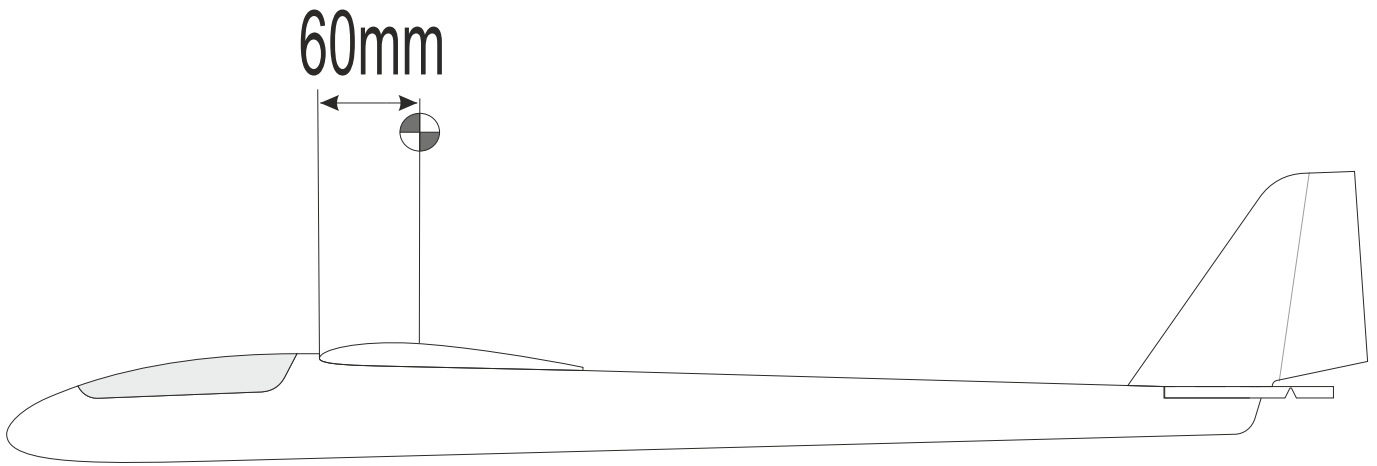

We wish you many happy flying hours with the Termik.

Your RC Factory team