

**Fokker Dr. 1**  
#15134  
**Bauanleitung**

**PICHLER**

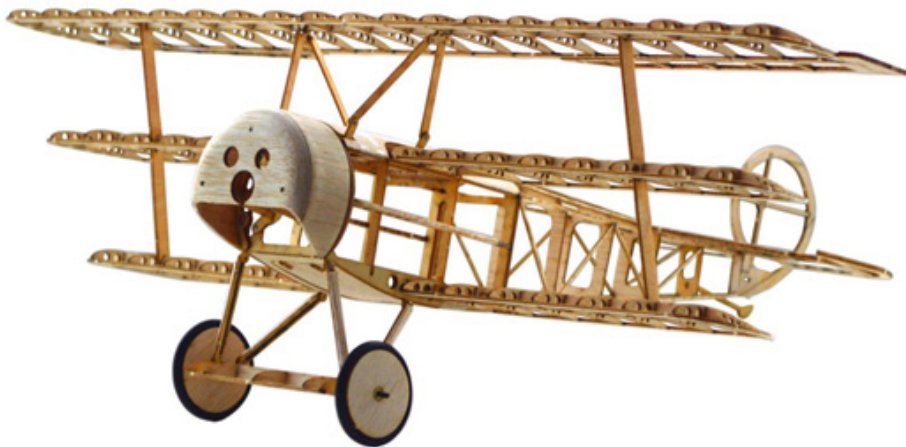

| <b>Packungsinhalt</b> |    |
|-----------------------|----|
| Balsaholzplatte       | 4  |
| Lindenholzplatte      | 1  |
| Kohlefaserstab        | 2  |
| Micro Scharnier       | 1  |
| Micro Schraube        | 20 |
| Rad                   | 2  |
| Schrumpfschlauch      | 1  |
| Mini Magnet           | 8  |
| Bauplan               | 3  |
| Bespannpapier         | 1  |

# Teil 1 - Rahmen

1



2

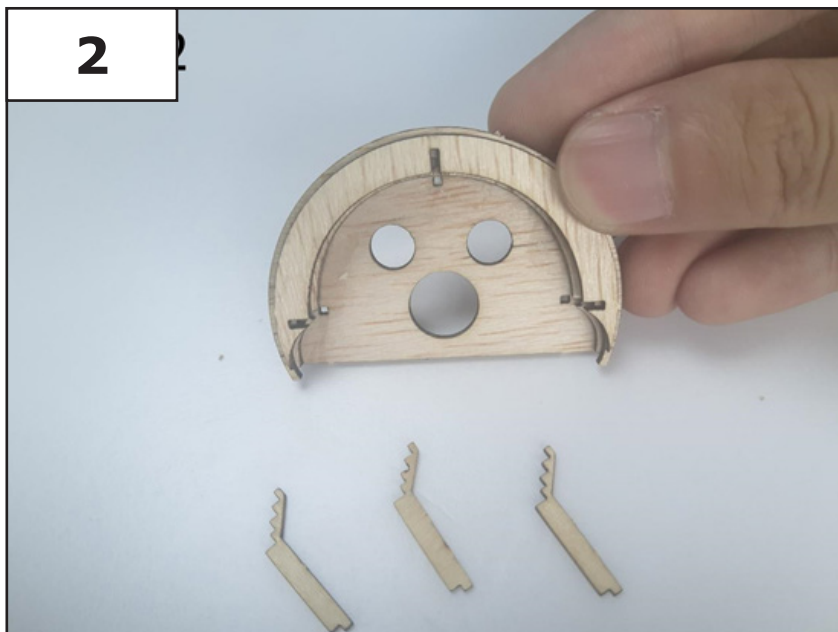

3



## Teil 1 - Rahmen

4

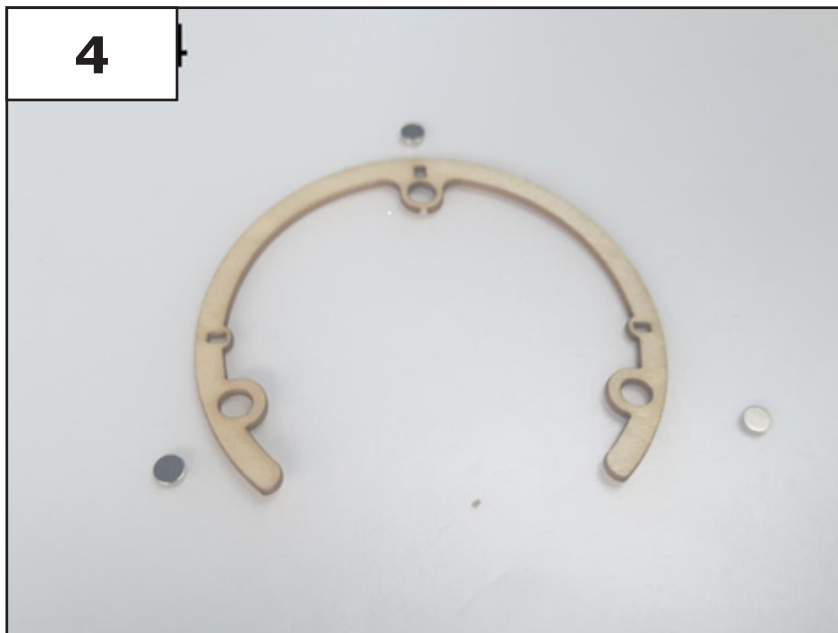

5

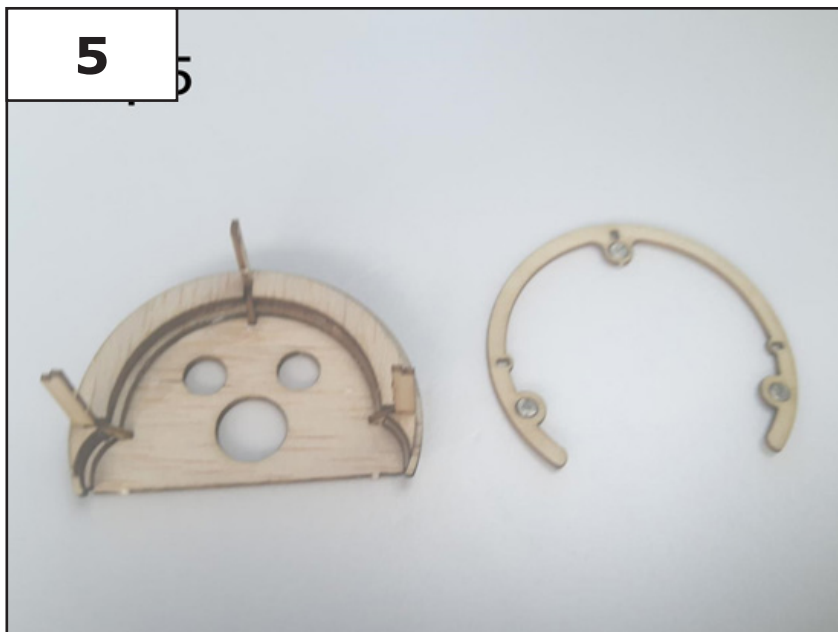

6

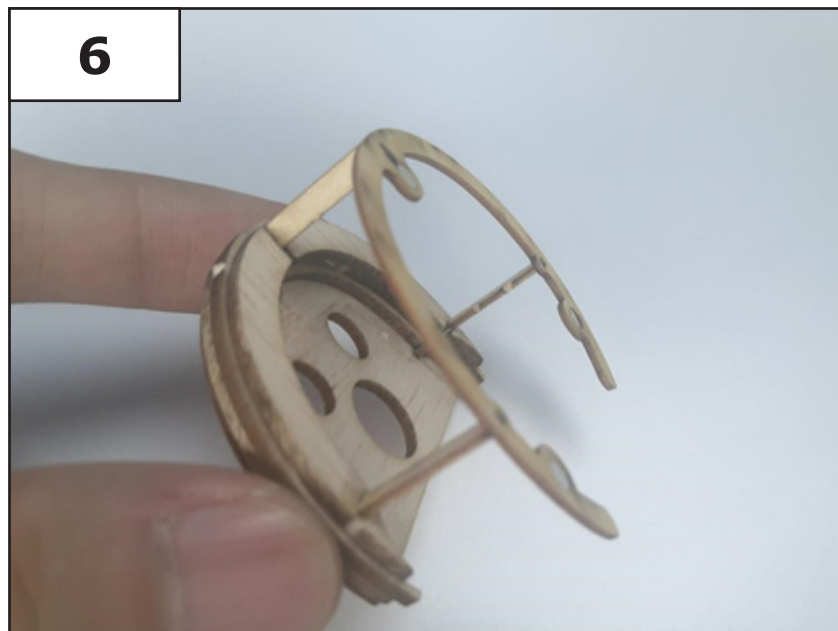

## Teil 1 - Rahmen

7



8



9



## Teil 1 - Rahmen

10

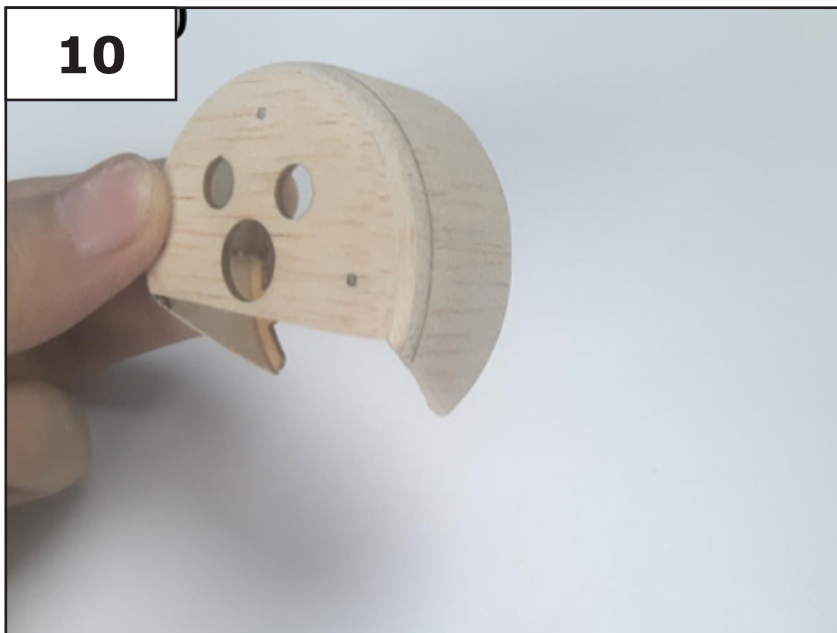

11

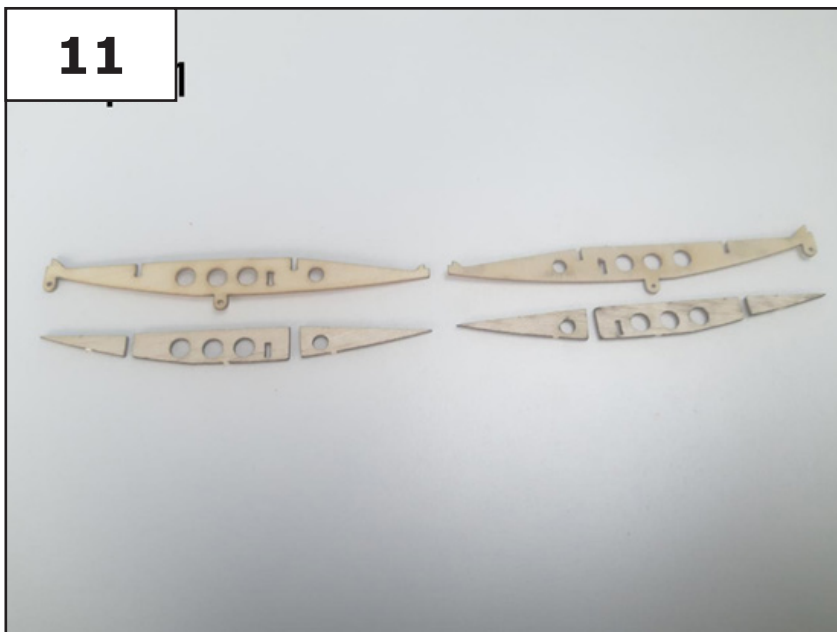

12

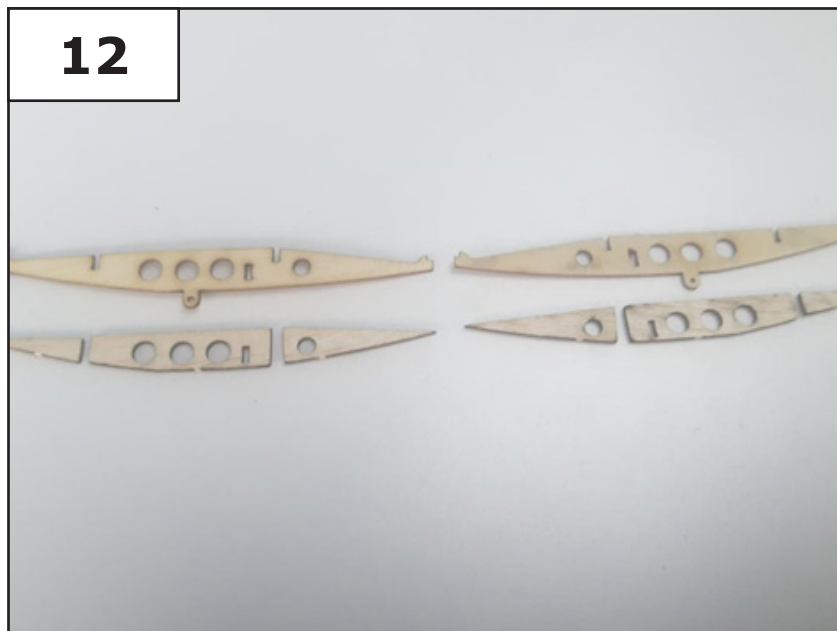

# Teil 1 - Rahmen

13

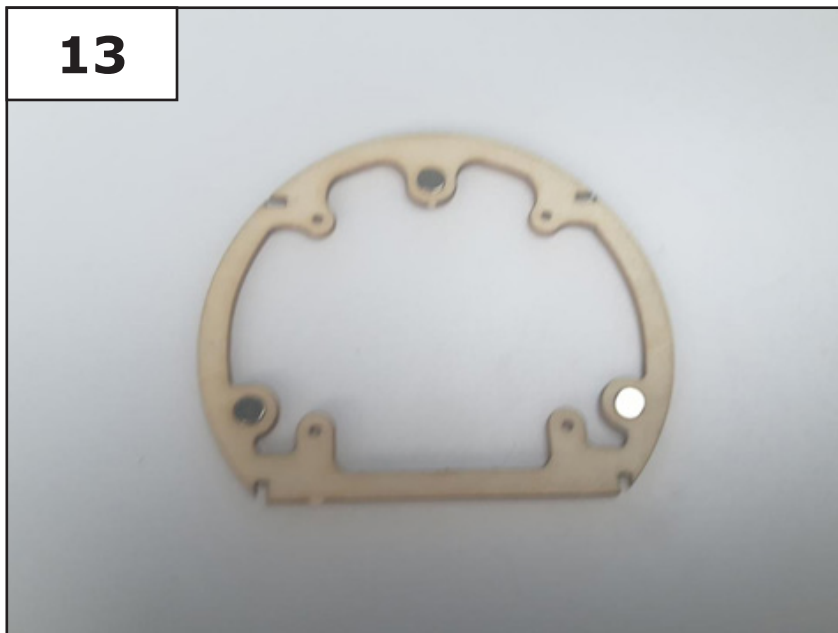

14

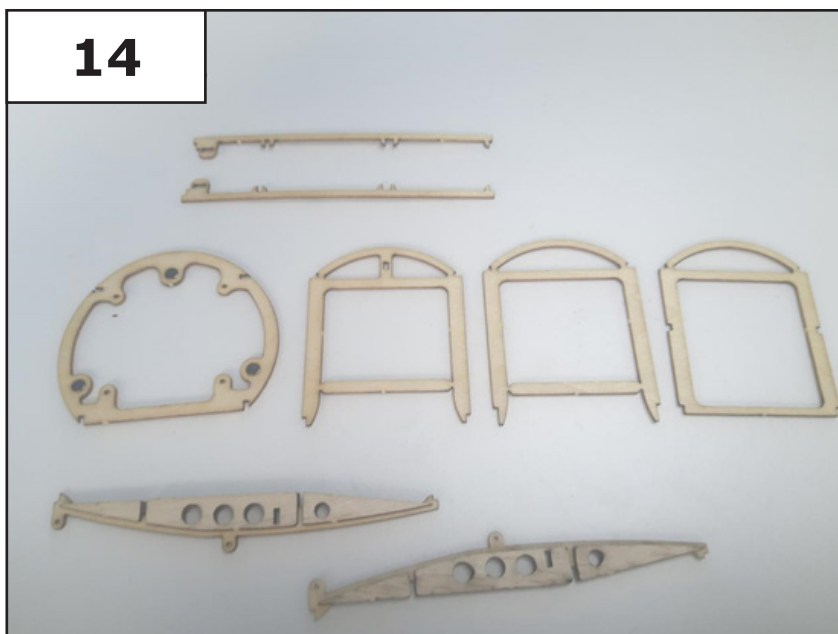

15

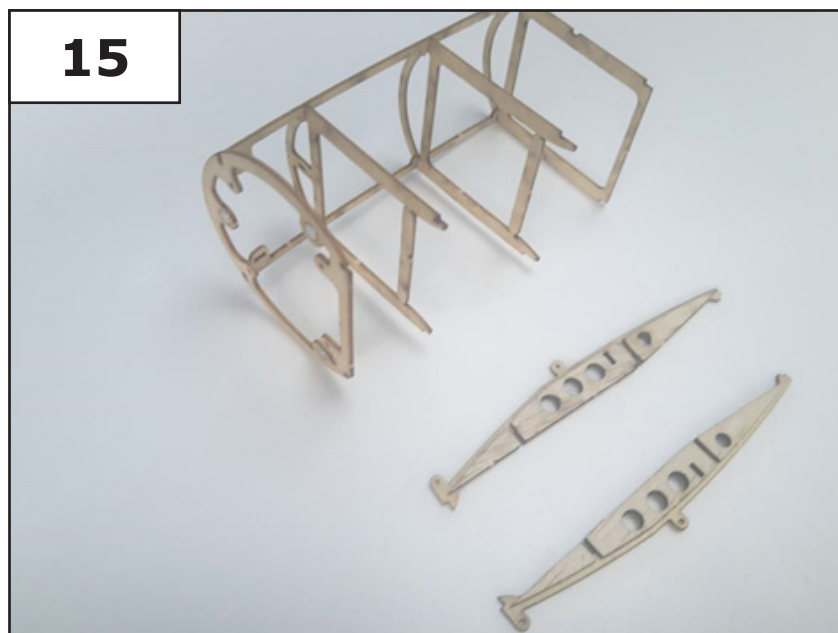

## Teil 1 - Rahmen

**13**

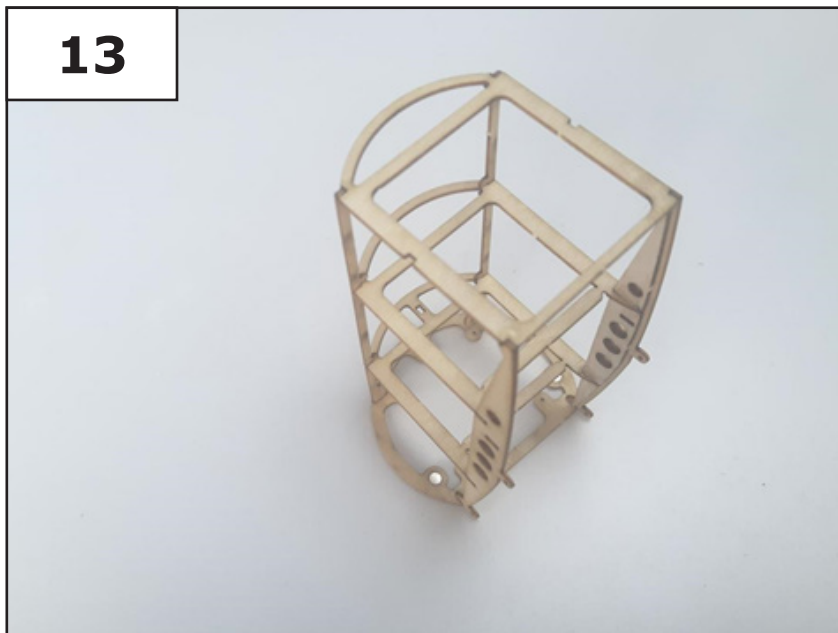

**17**

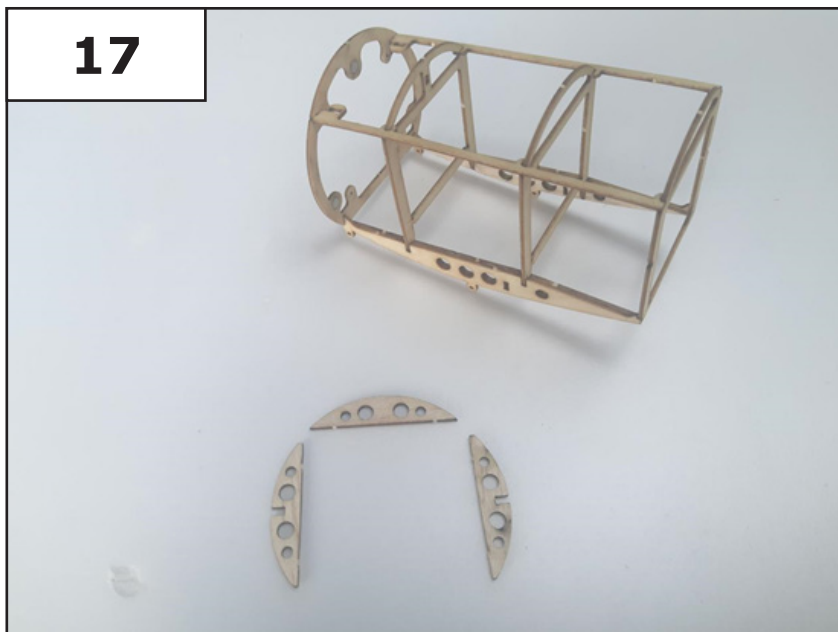

**18**

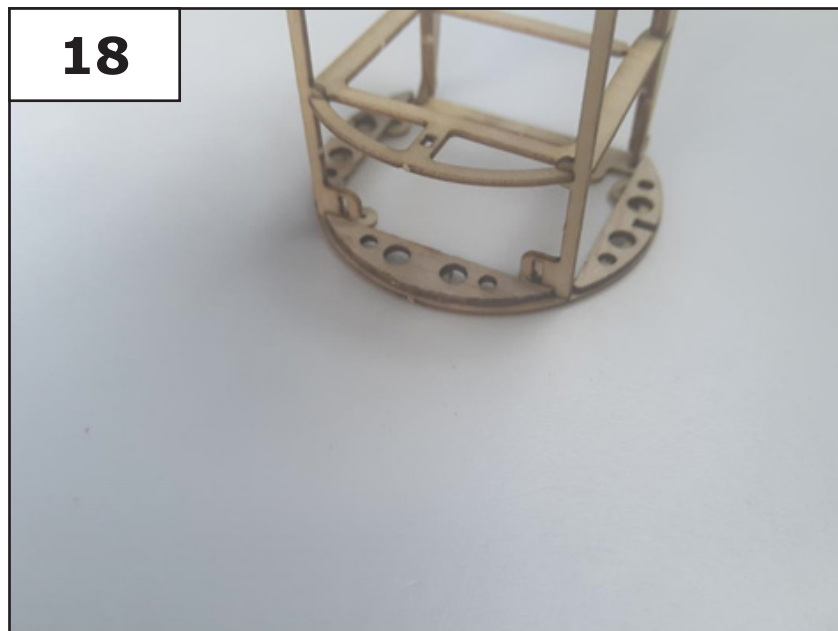

## Teil 1 - Rahmen

19

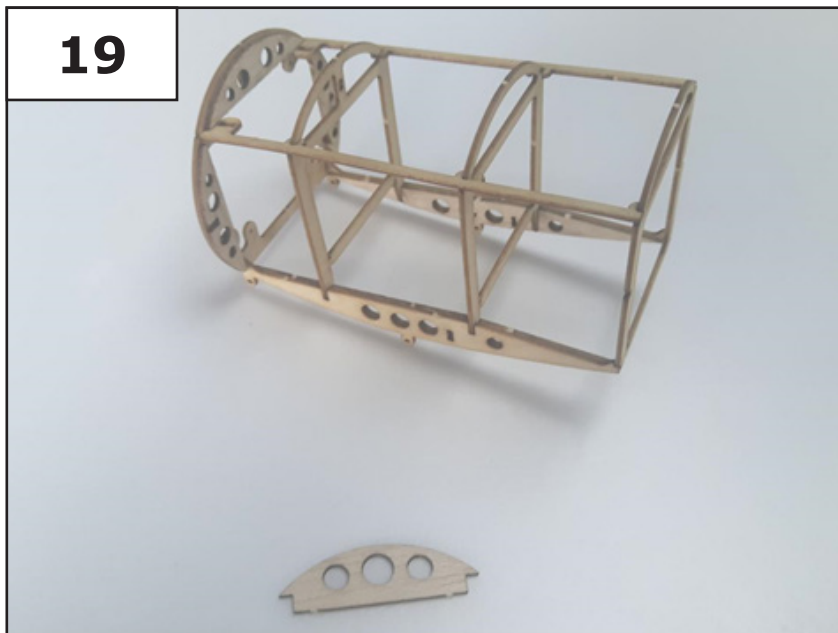

20

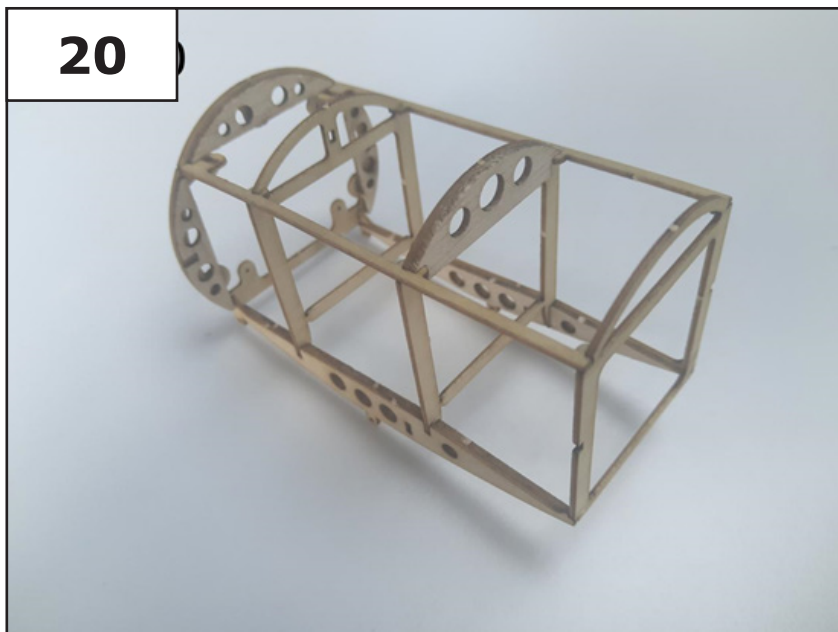

21

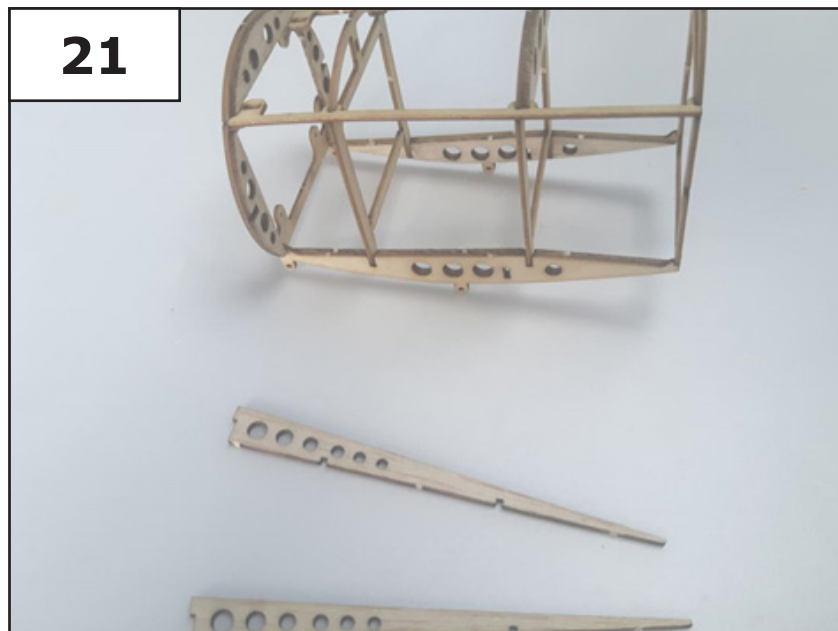



## Teil 1 - Rahmen

22

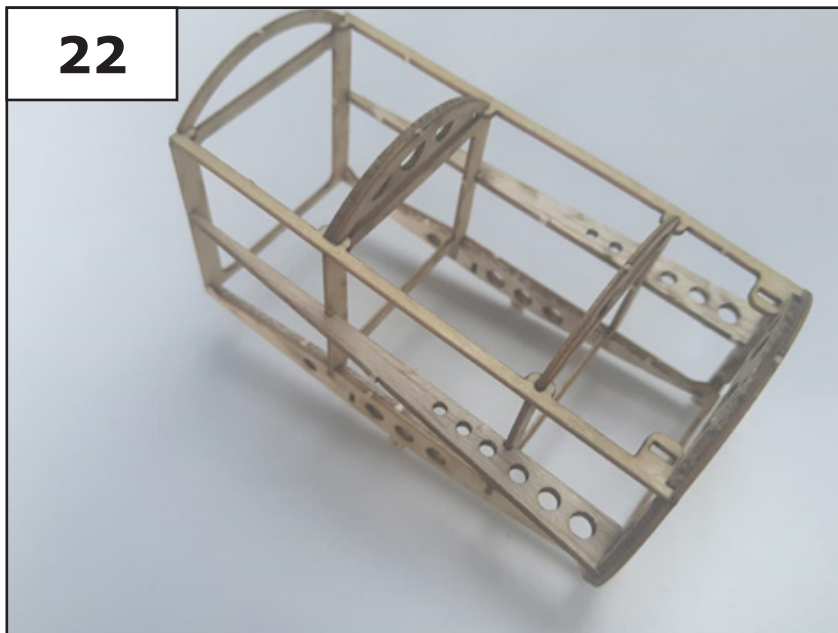

23

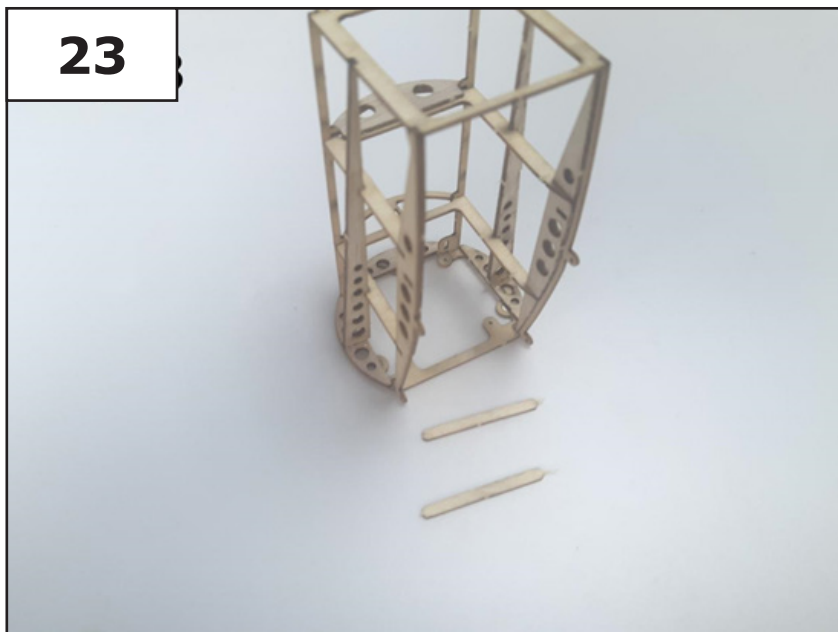

24

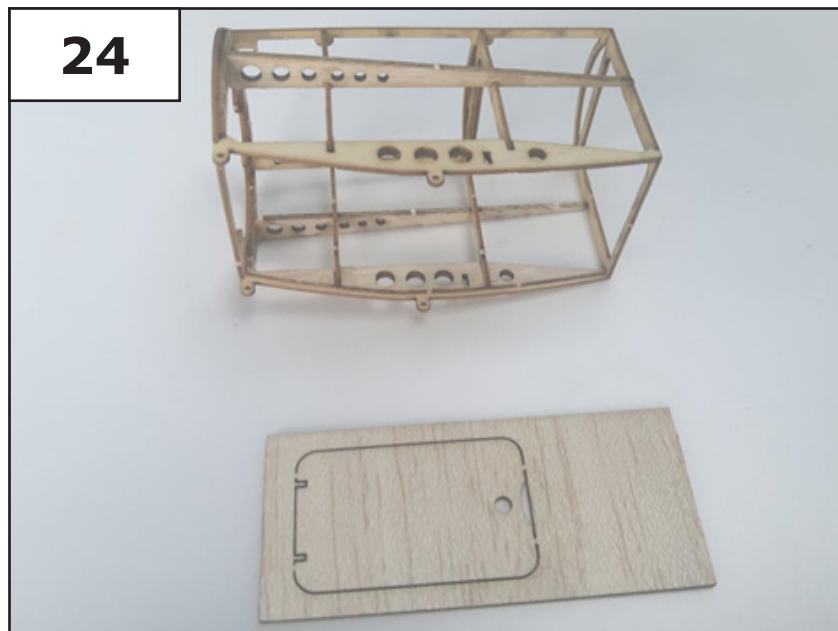

## Teil 1 - Rahmen

24

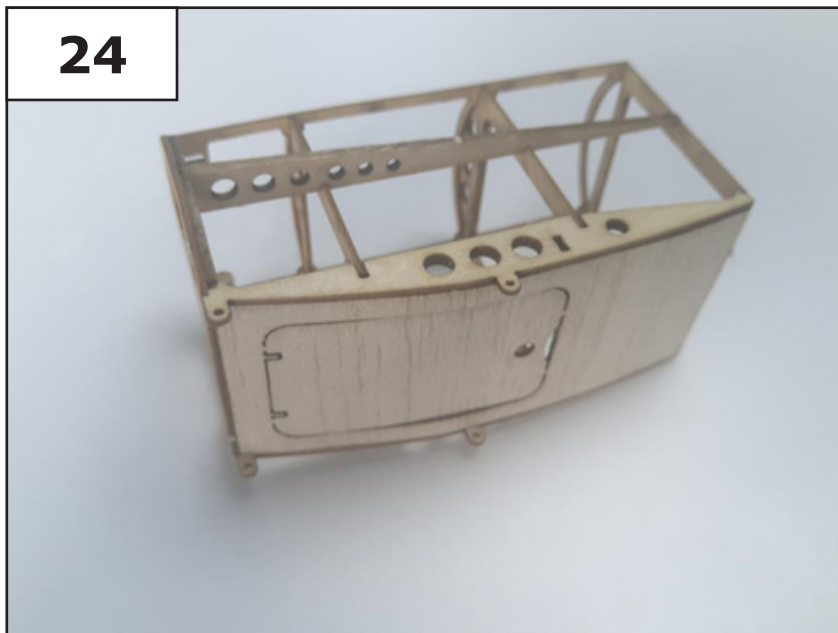

26

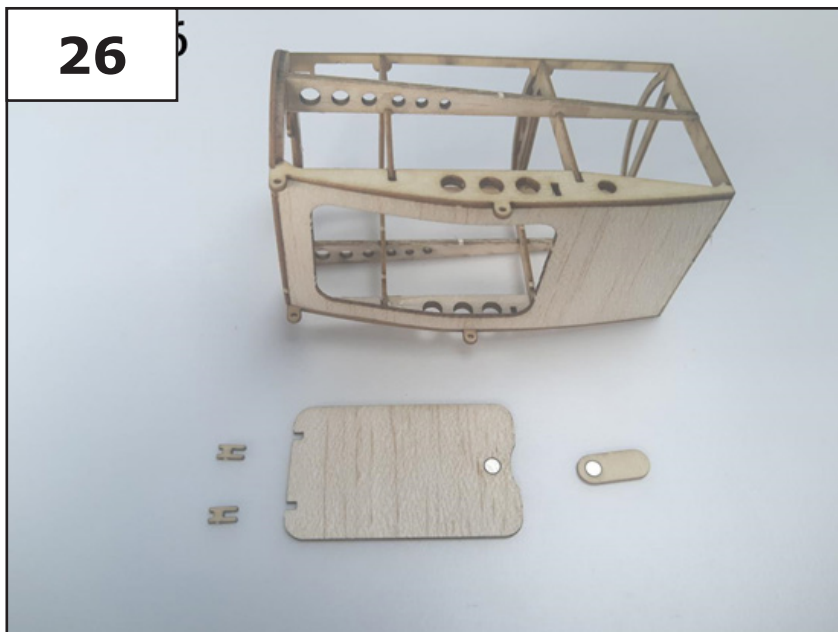

27

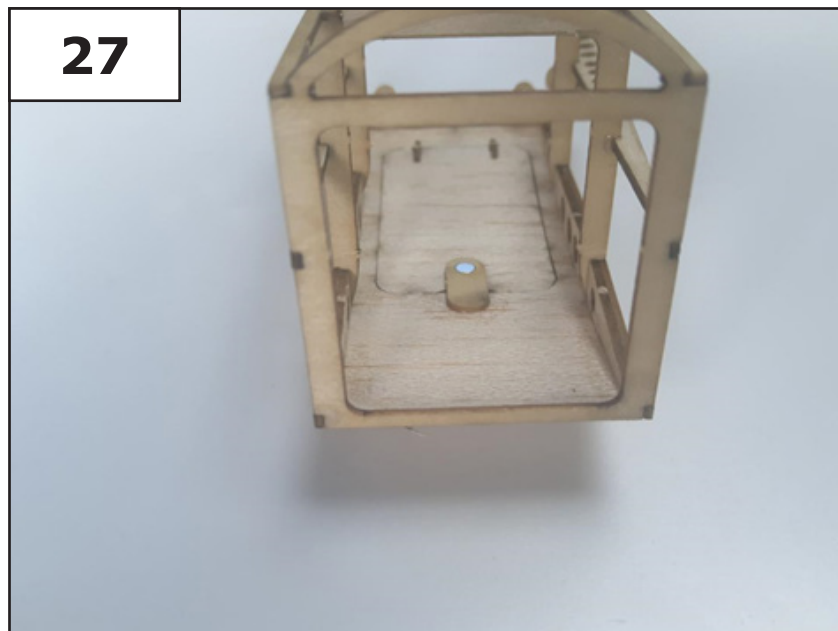

## Teil 1 - Rahmen

28

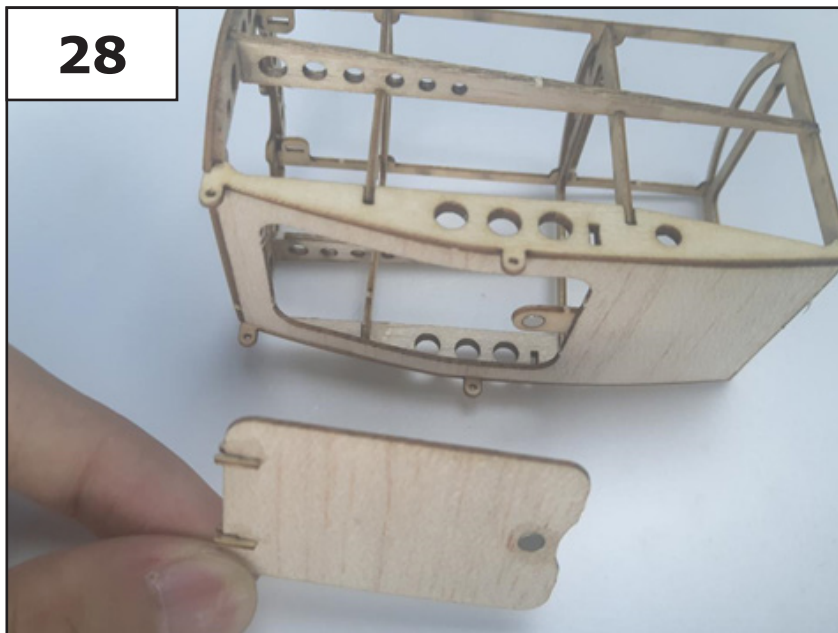

29

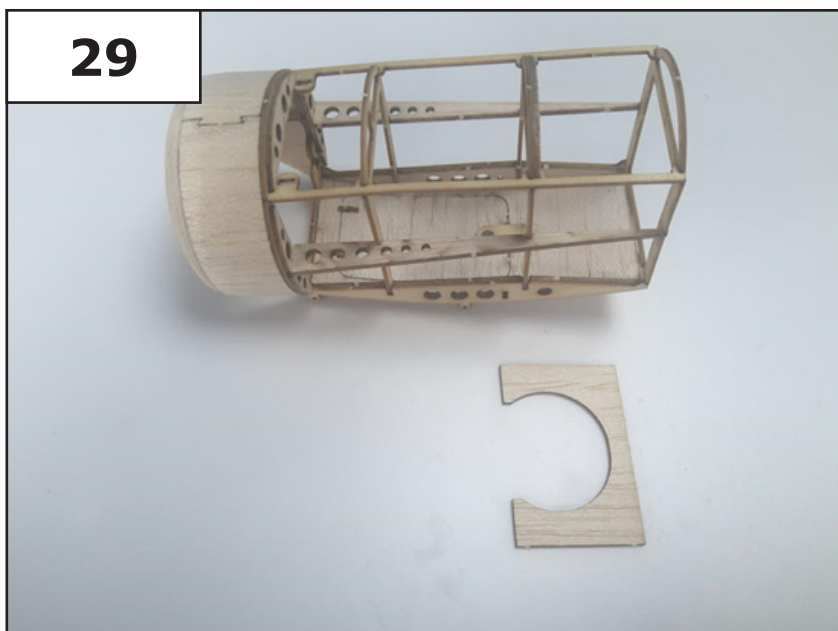

30

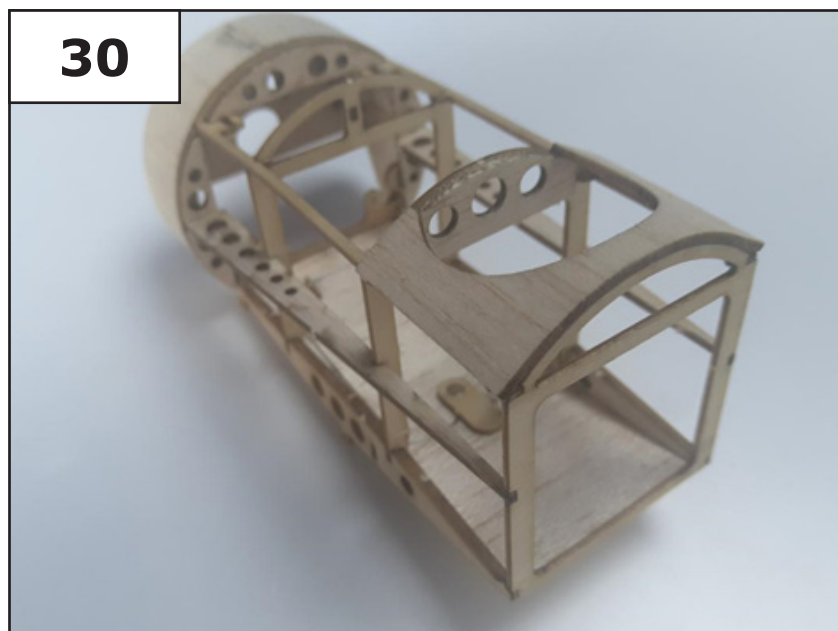

## Teil 1 - Rahmen

31

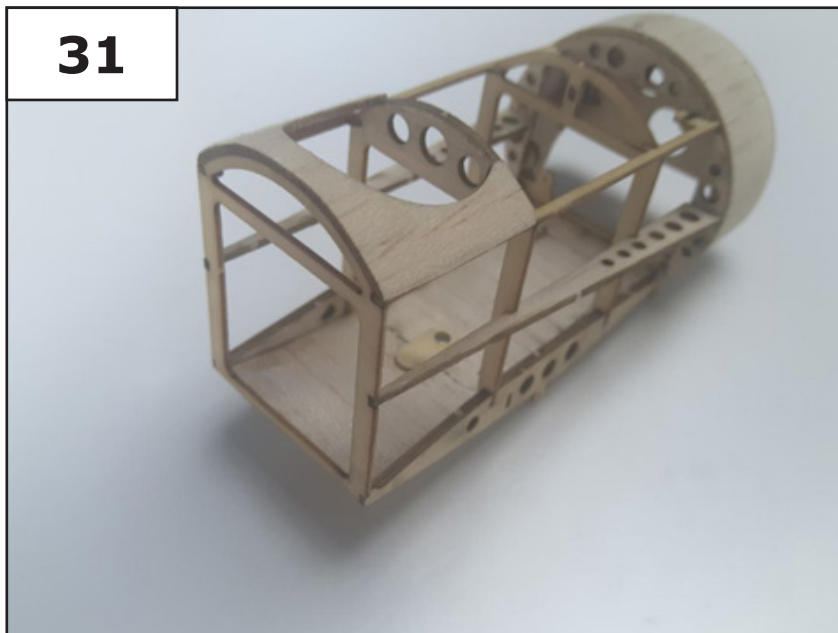

32

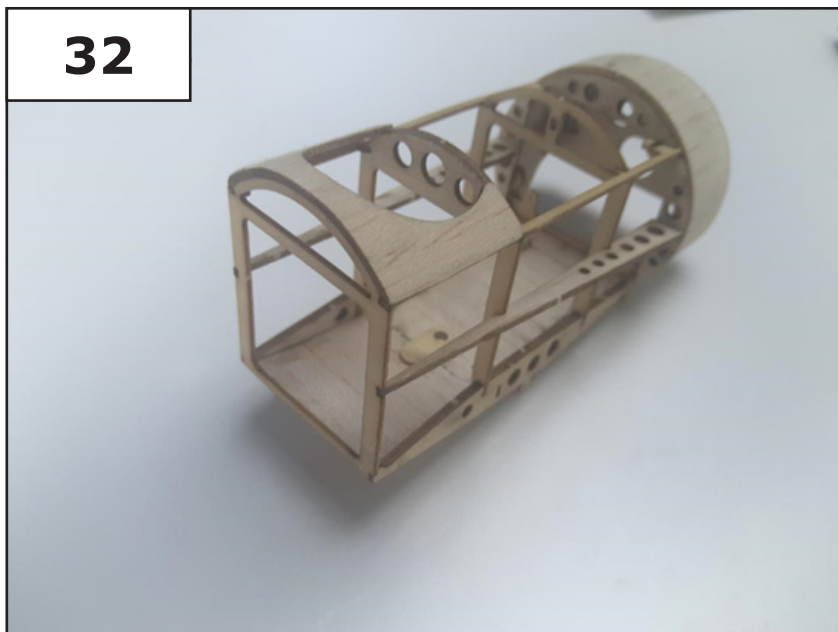

33

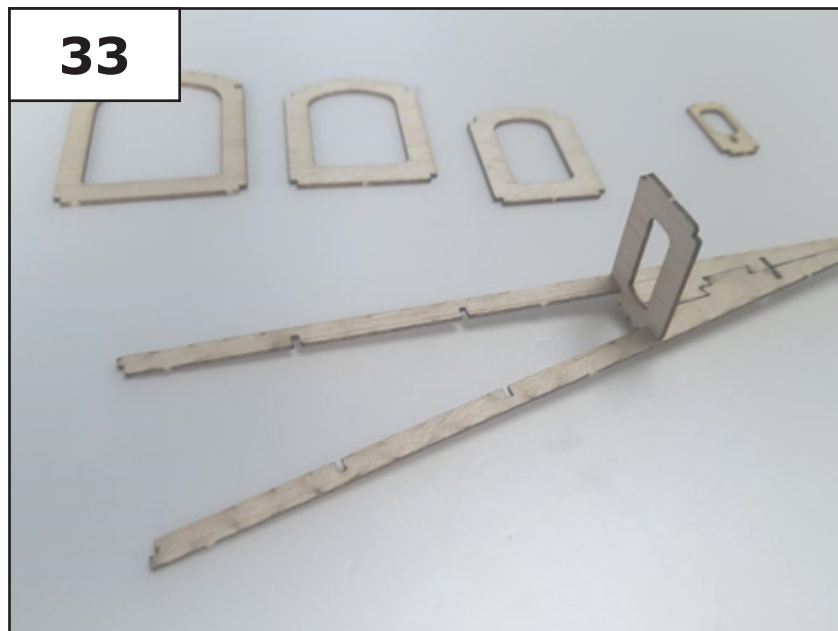

## Teil 1 - Rahmen

34

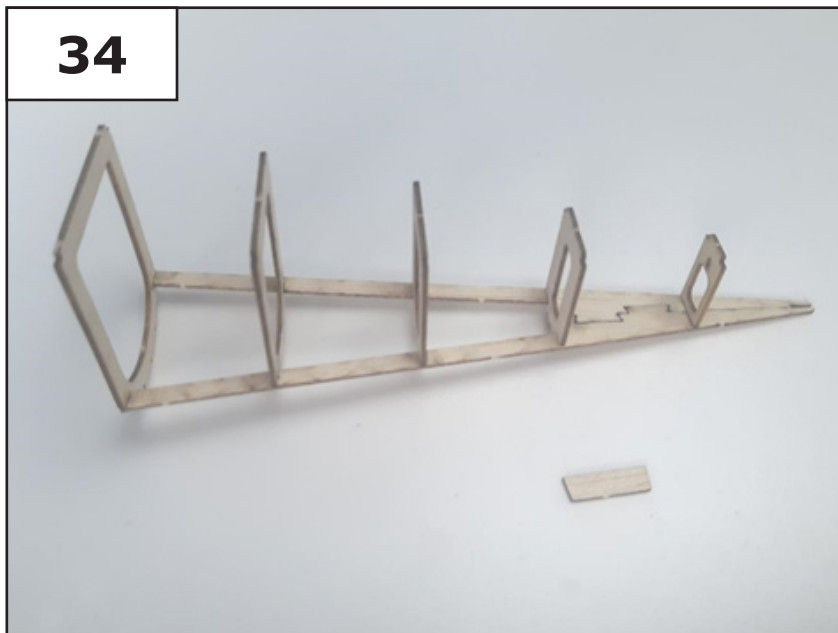

35

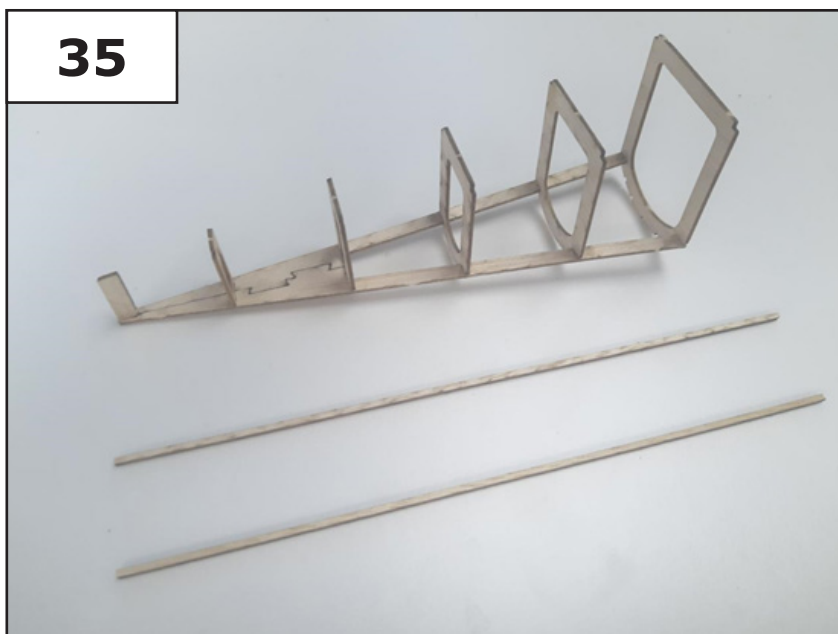

36

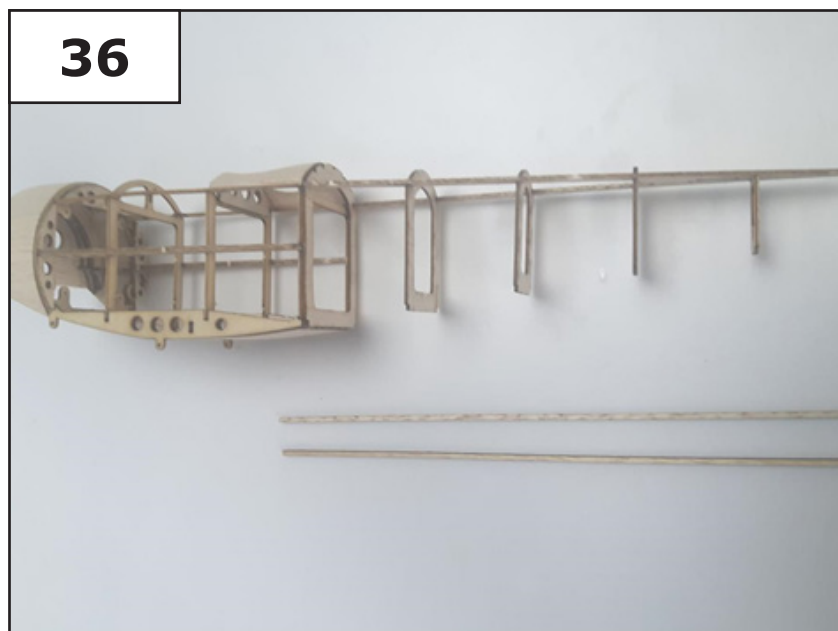

## Teil 1 - Rahmen

37

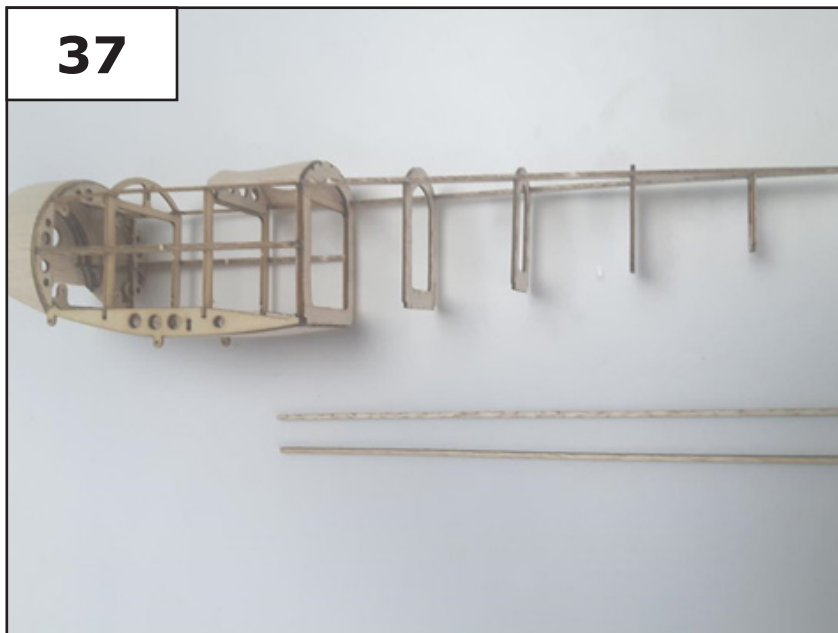

38

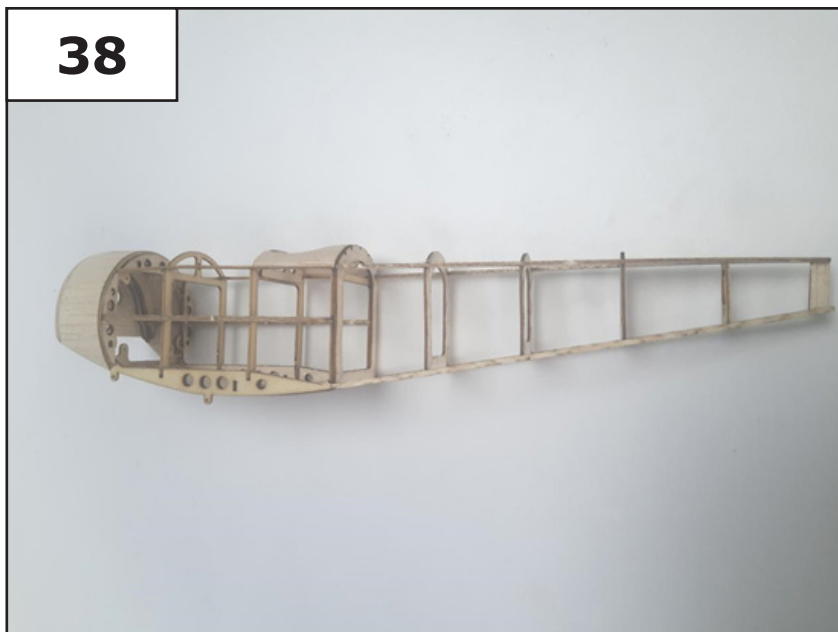

39

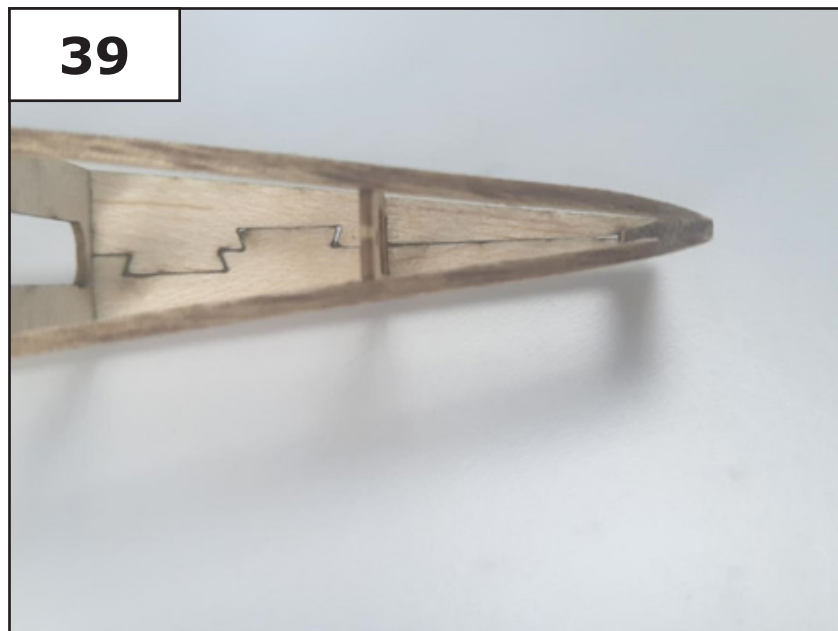

# Teil 1 - Rahmen

40



41

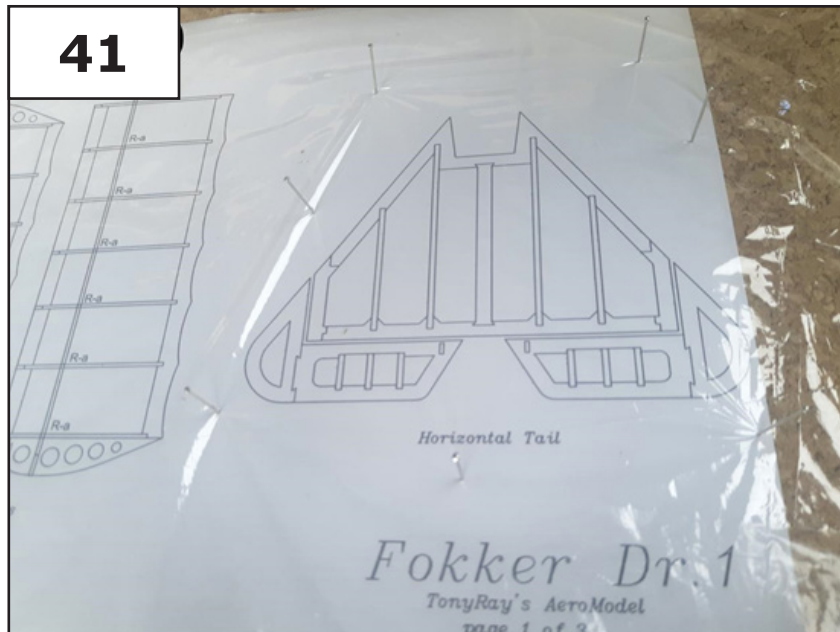

42

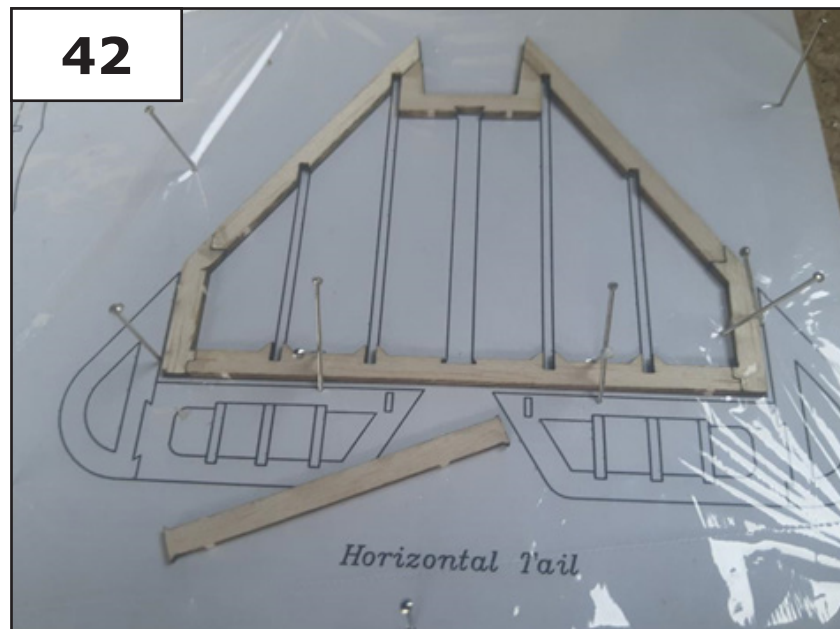

# Teil 1 - Rahmen

43

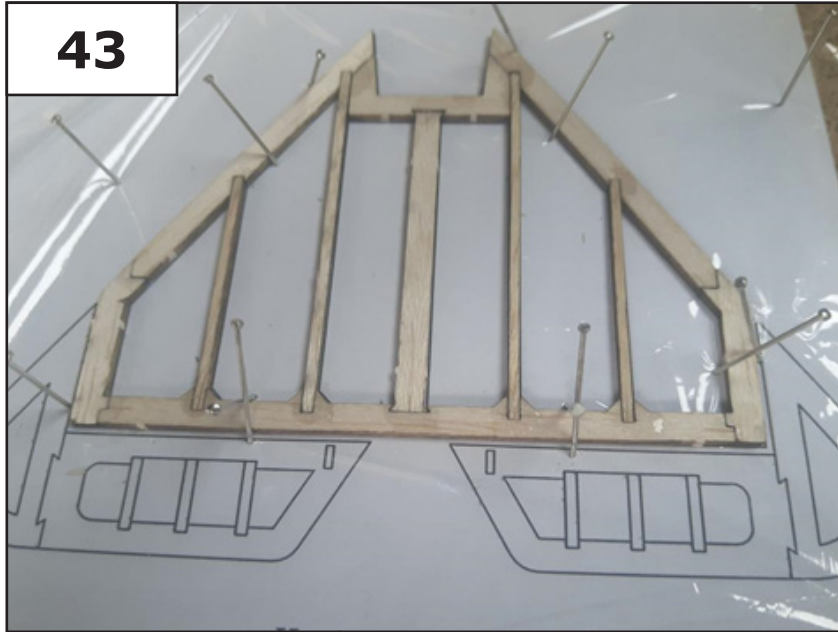

44

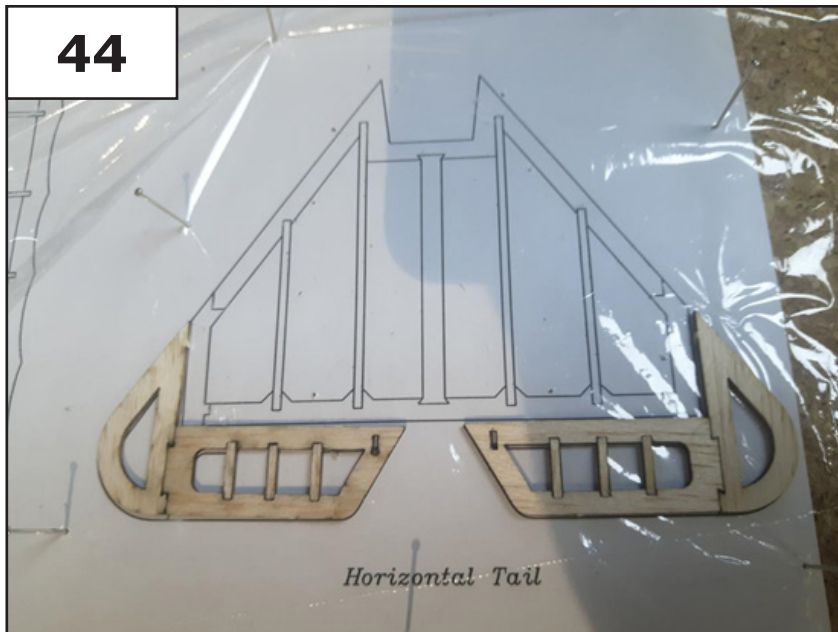

45

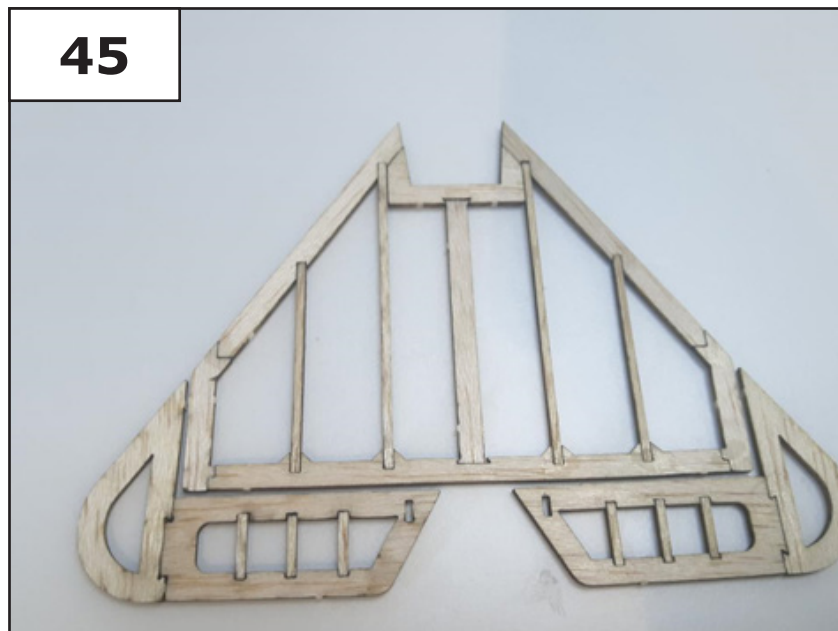



## Teil 1 - Rahmen

46

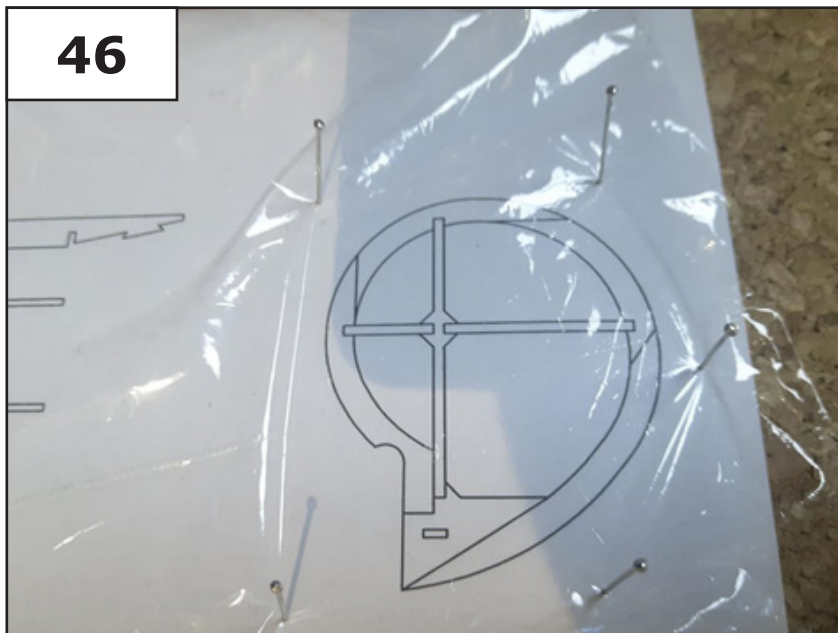

47

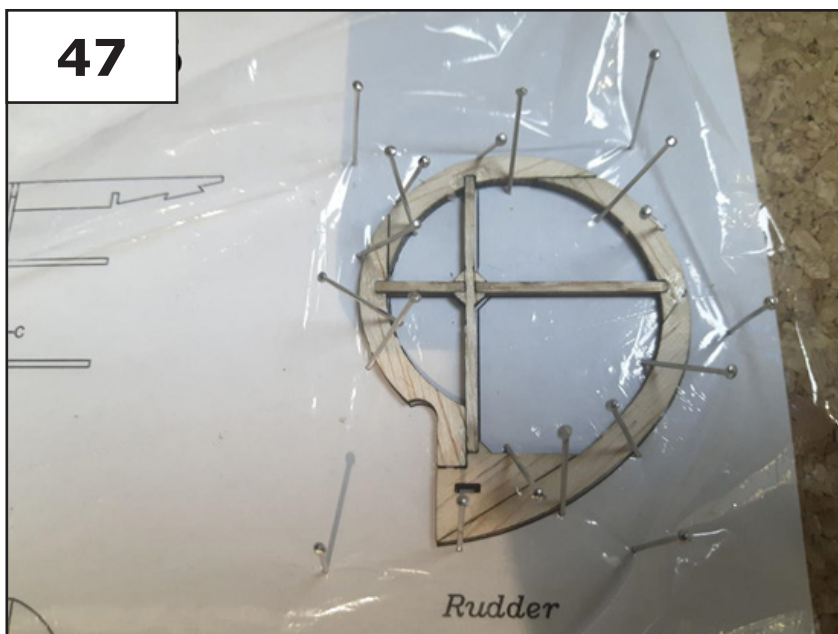

48



## Teil 1 - Rahmen

49

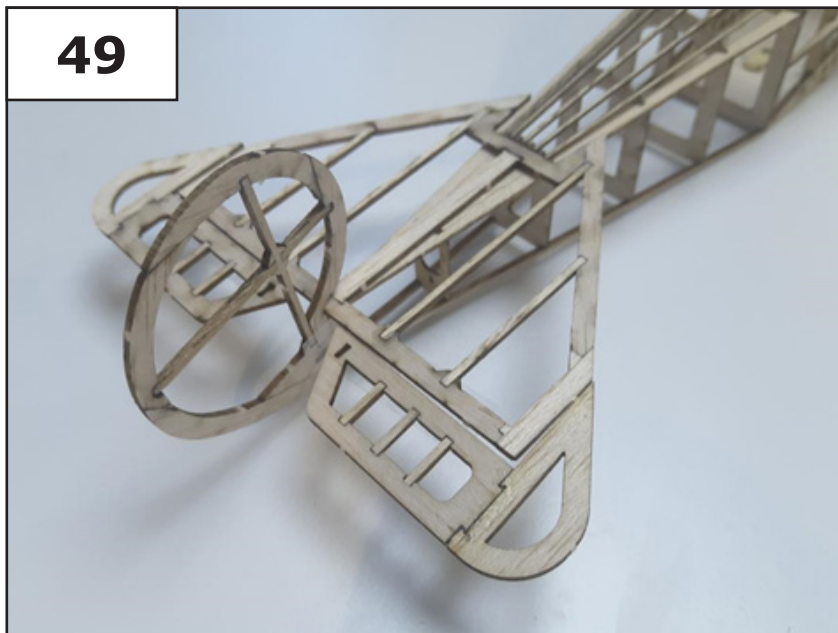

50



51

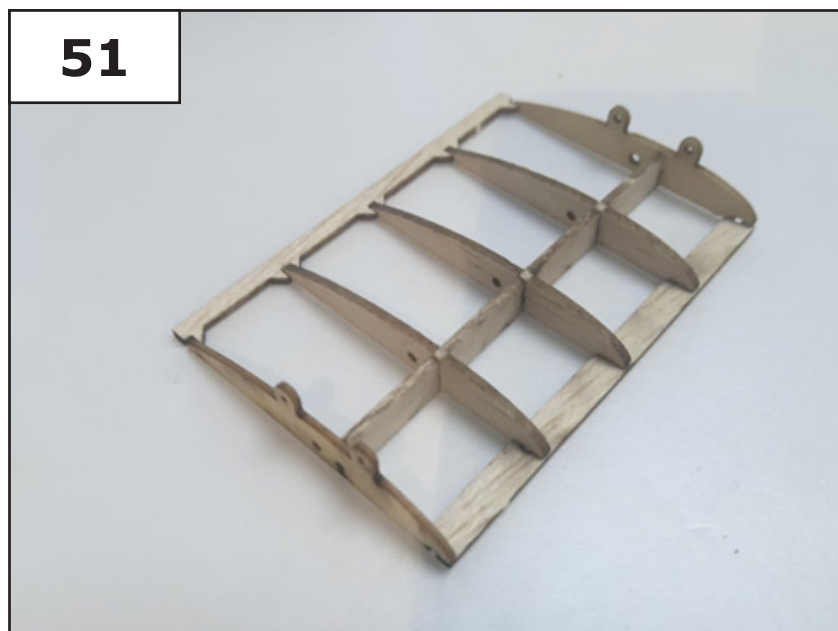

## Teil 1 - Rahmen

52

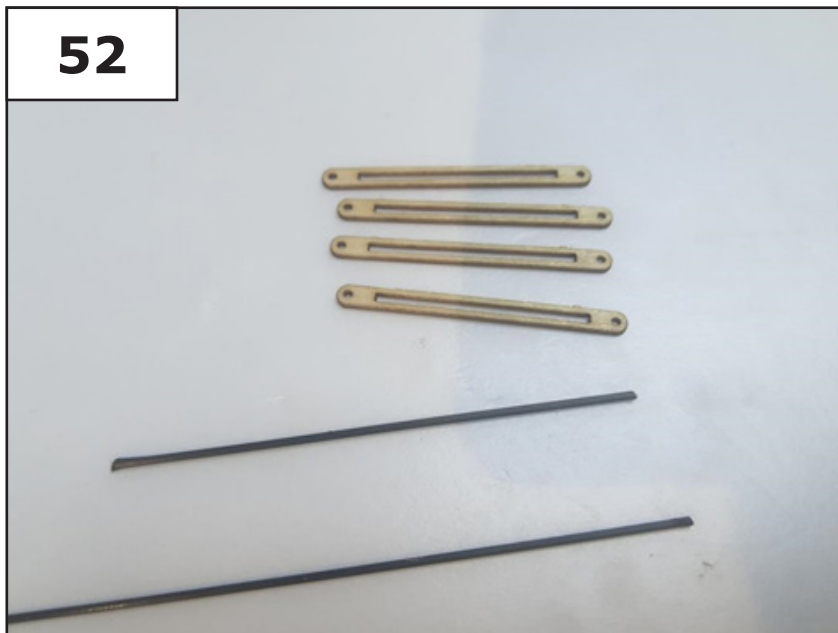

53

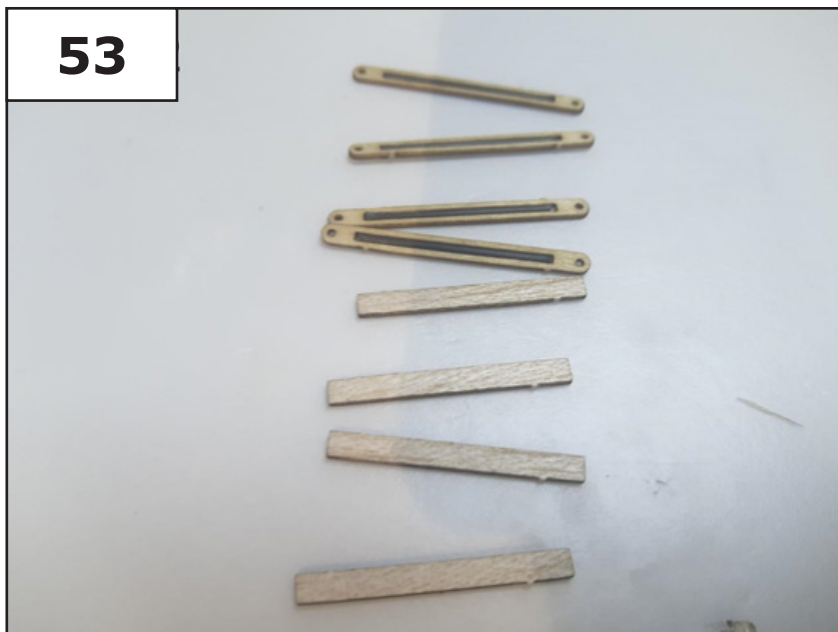

54



## Teil 1 - Rahmen

55

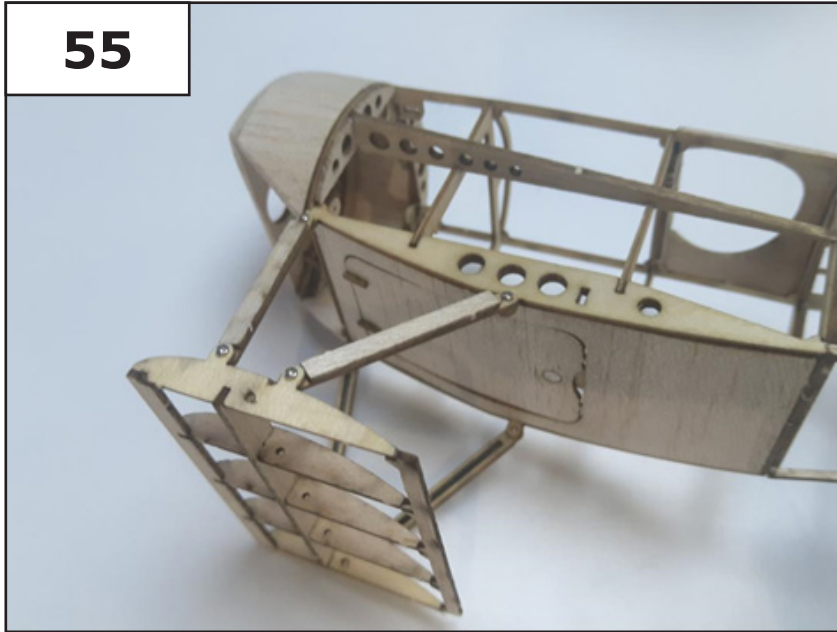

56

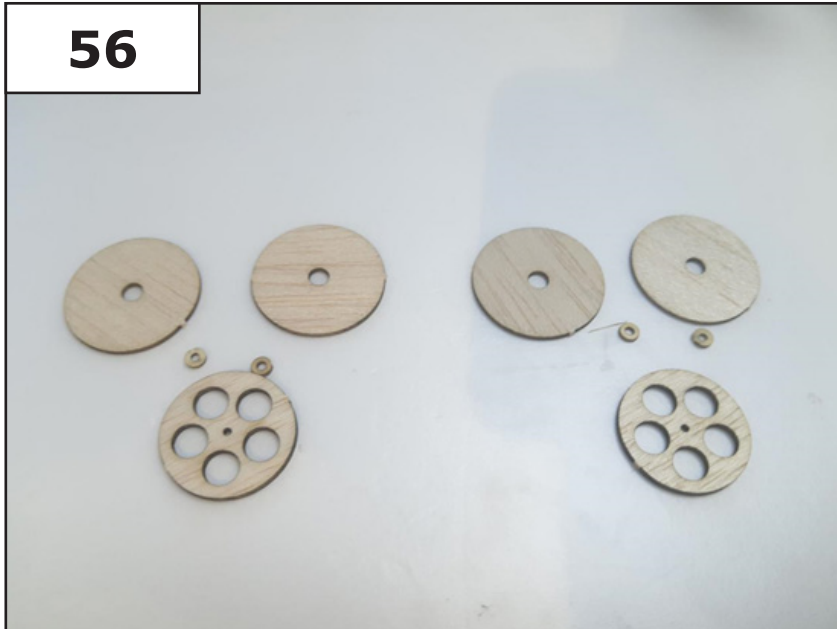

57

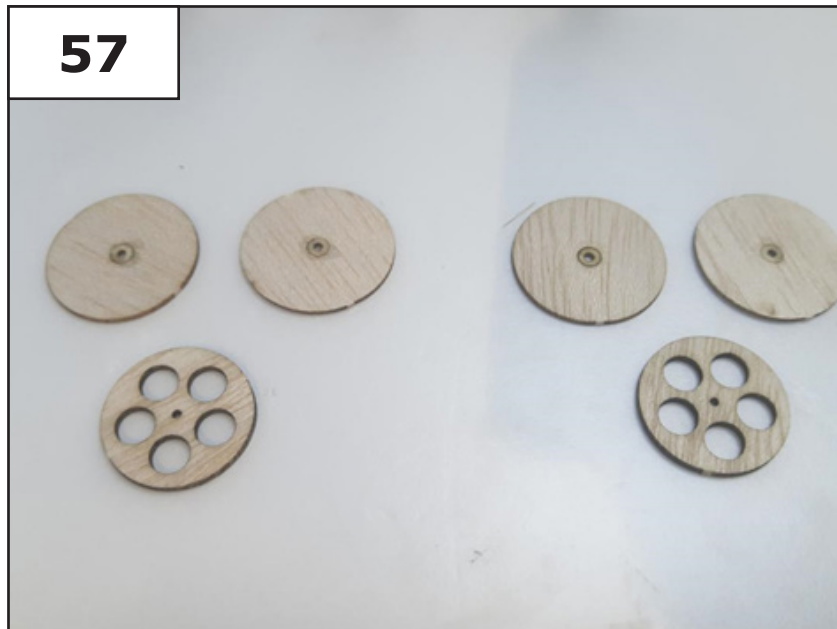

## Teil 1 - Rahmen

58

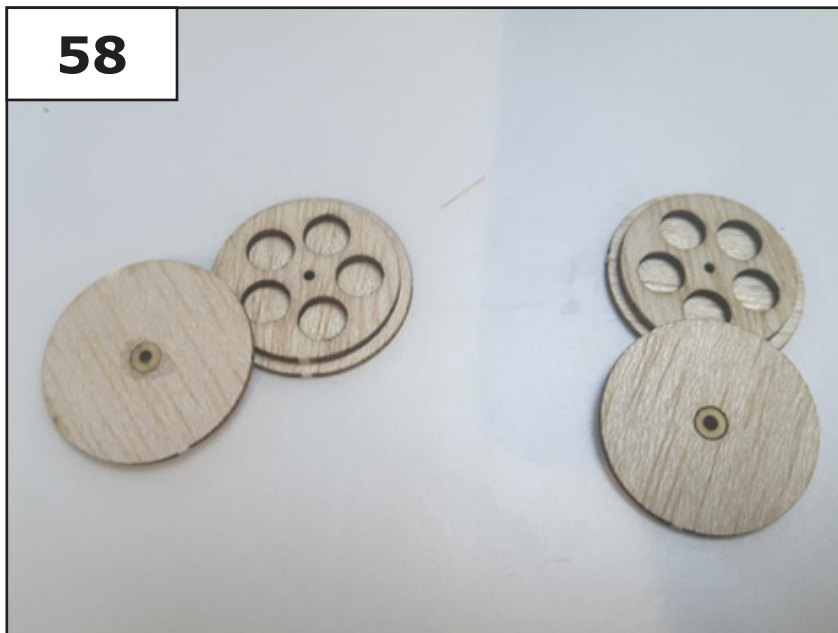

59

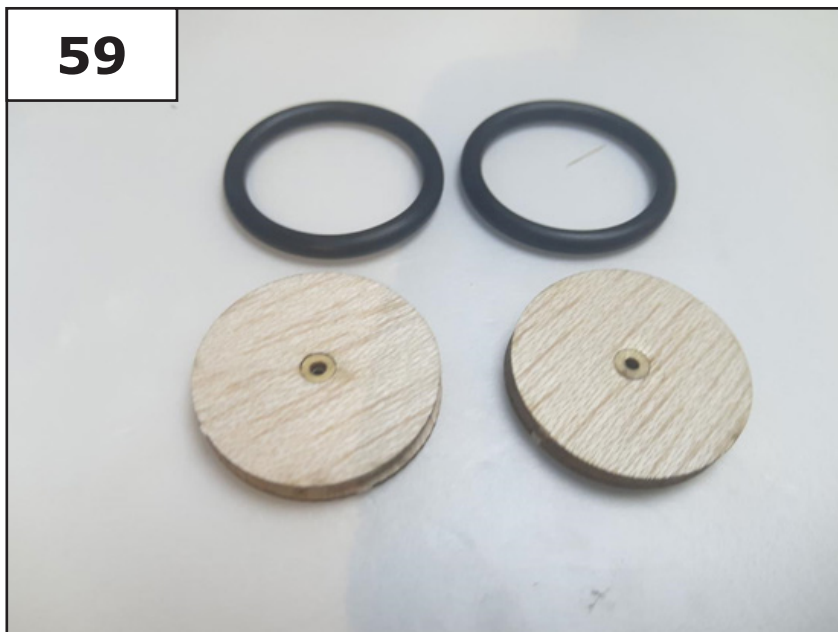

60



## Teil 1 - Rahmen

61

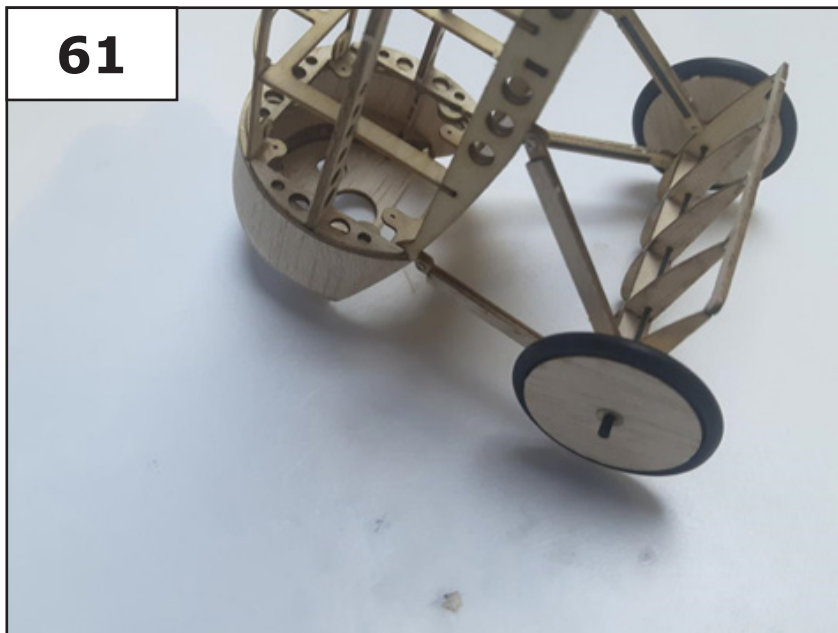

62

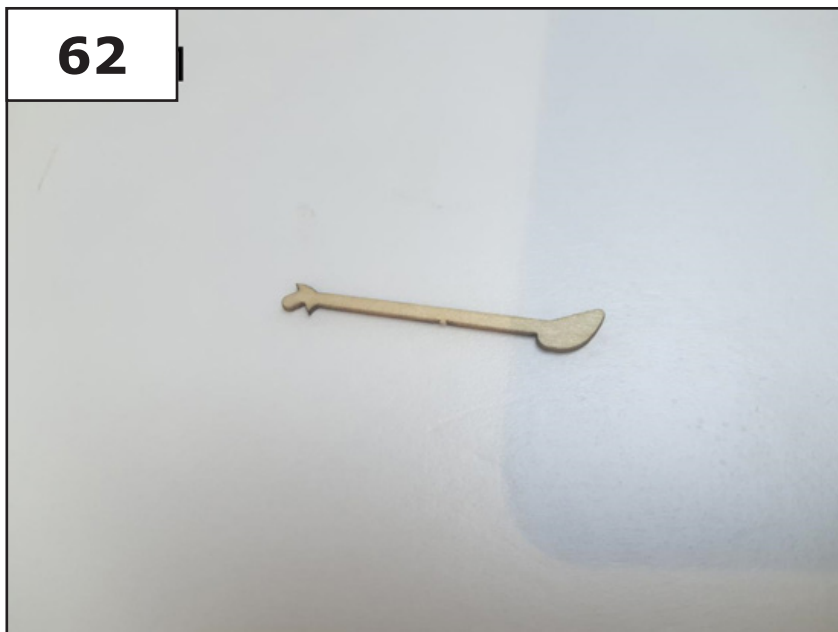

63



# Teil 1 - Rahmen

64



65



66



# Teil 1 - Rahmen

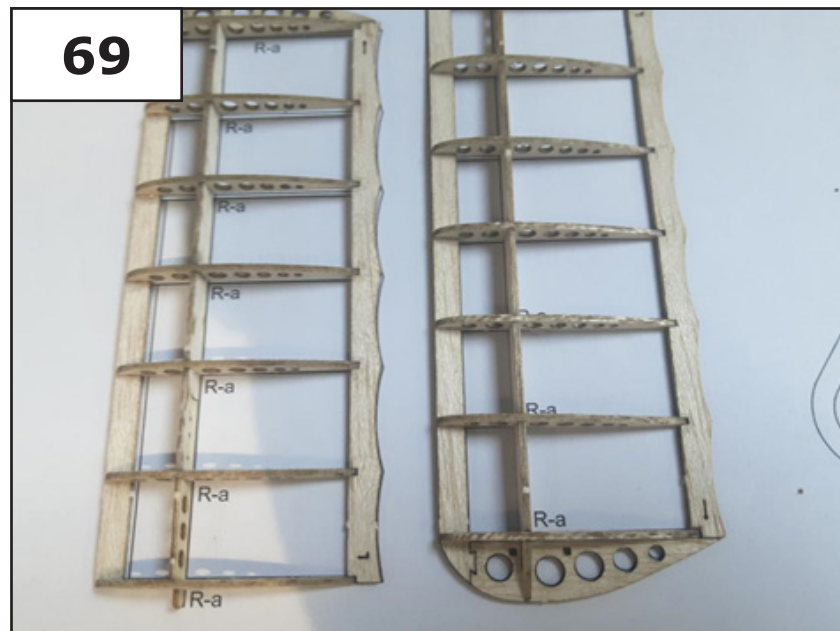
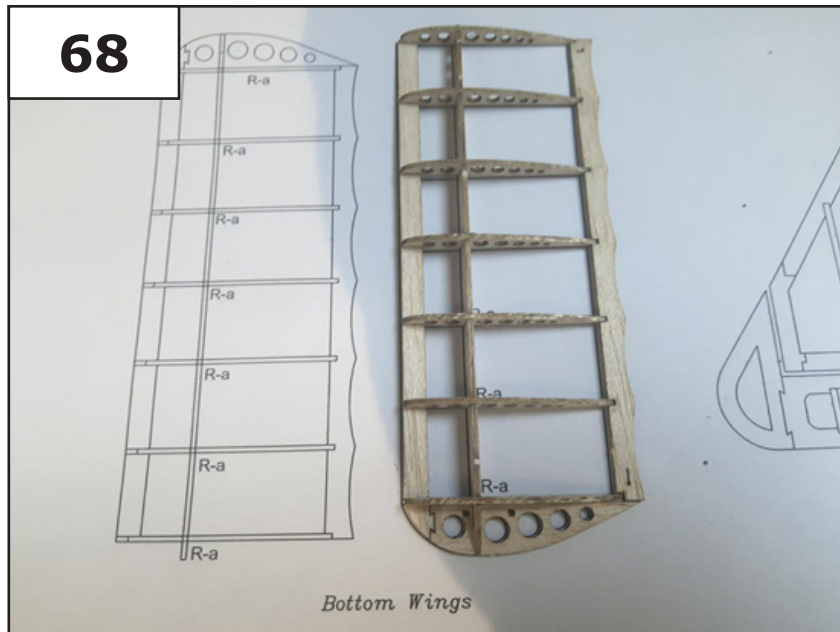
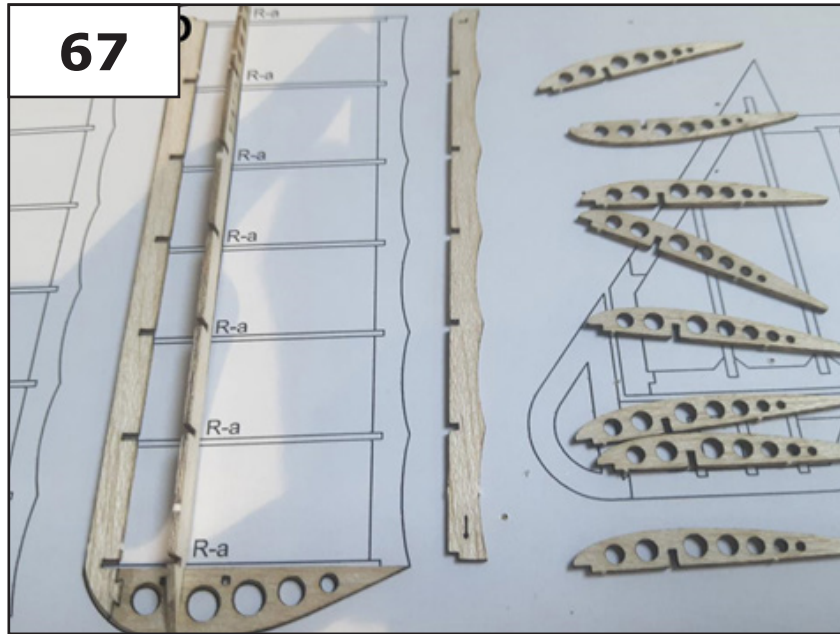



# Teil 1 - Rahmen

70

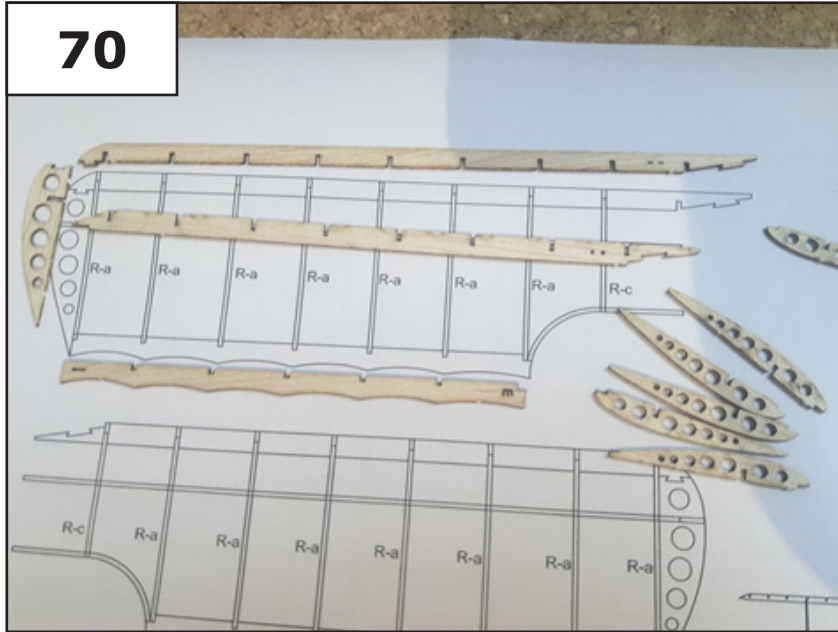

71

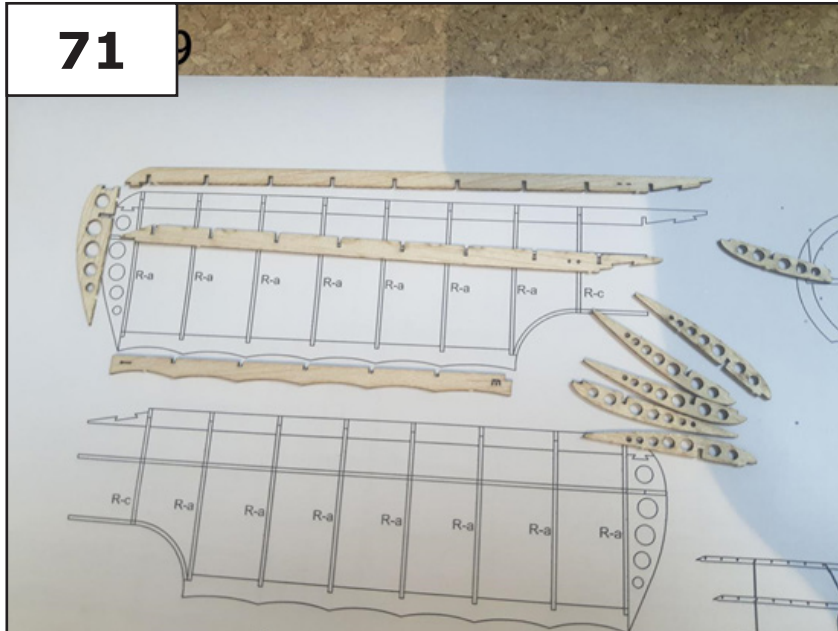

72

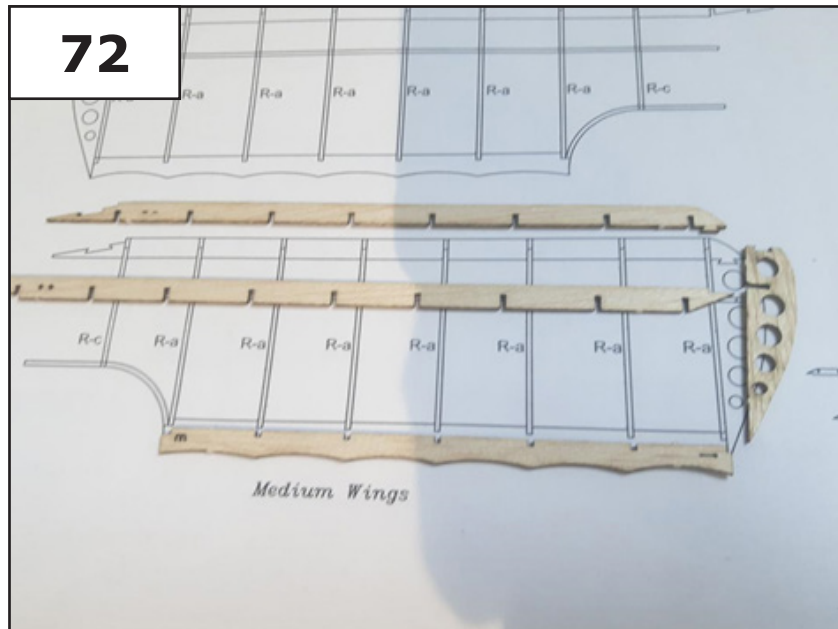

# Teil 1 - Rahmen

73

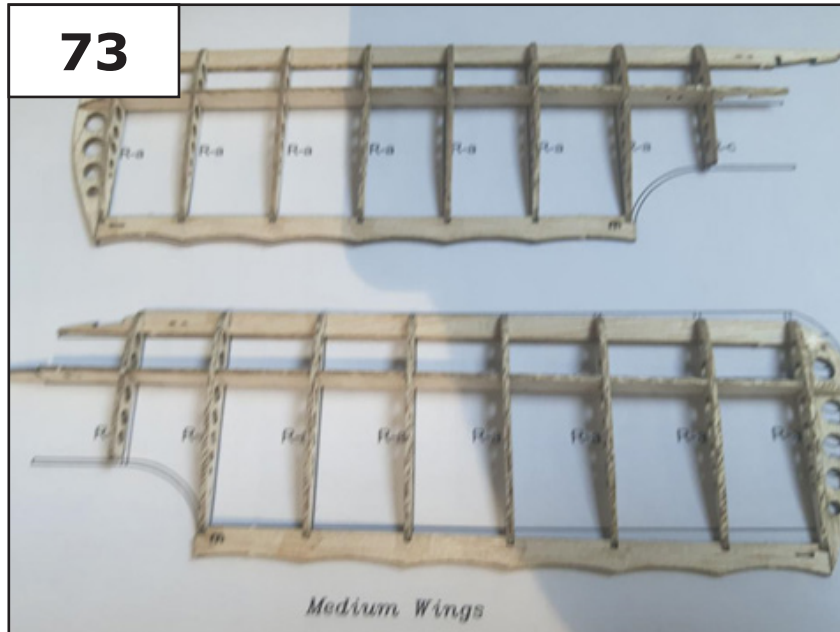

74

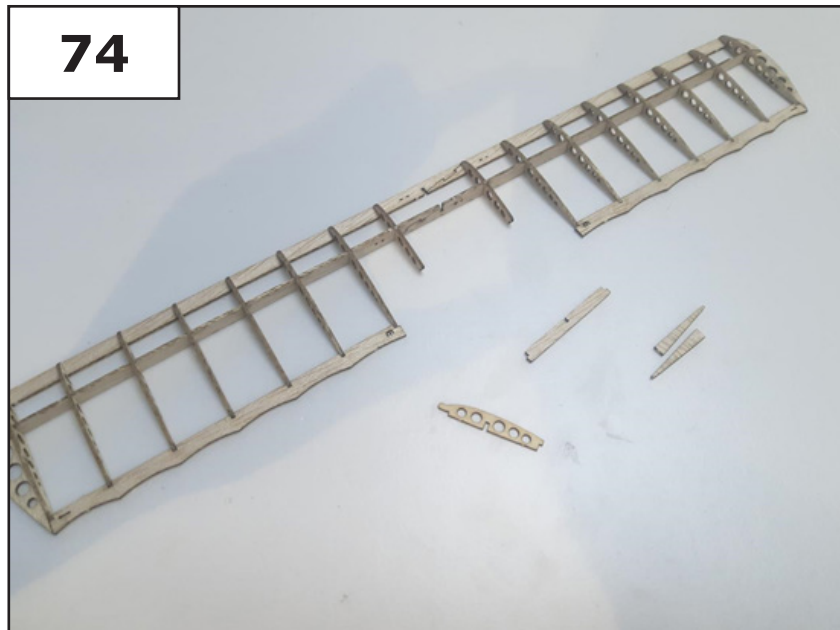

75

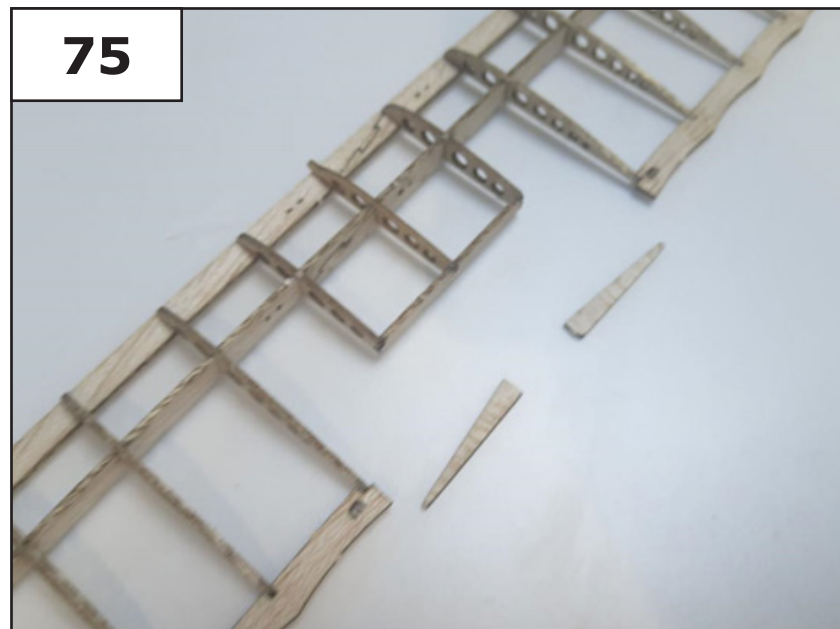

# Teil 1 - Rahmen

76

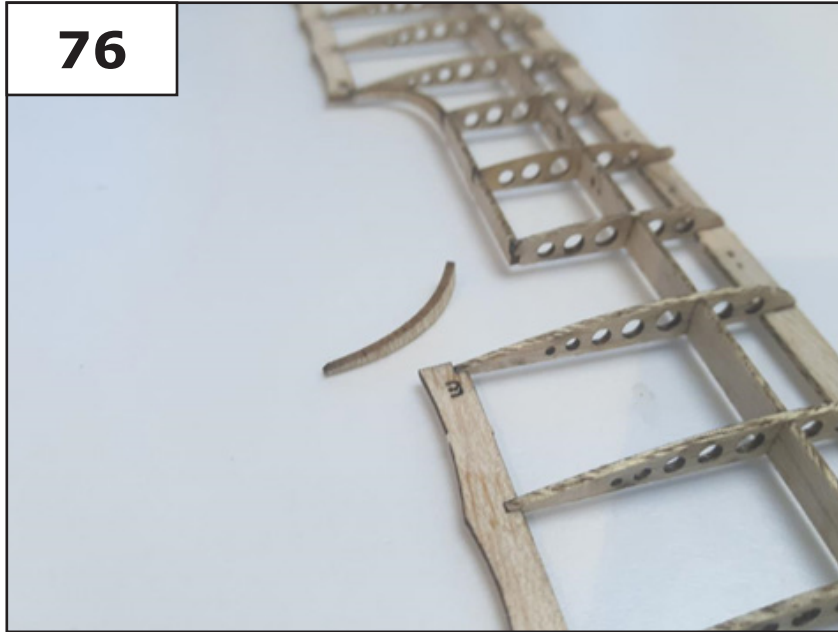

77

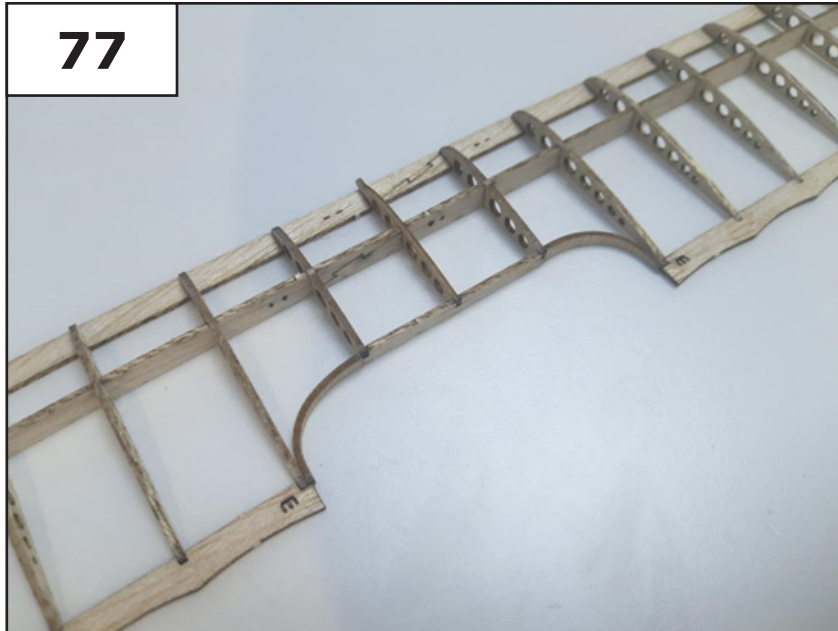

78

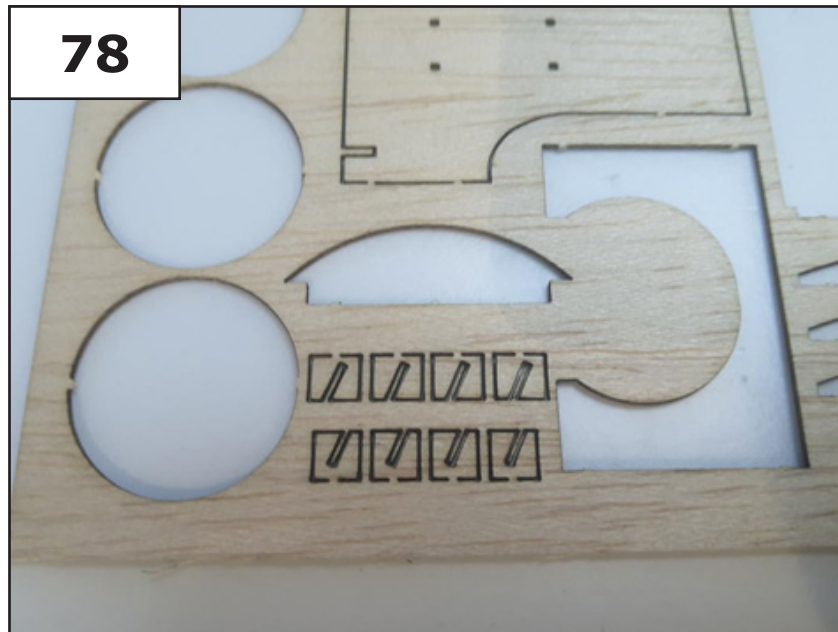

# Teil 1 - Rahmen

79

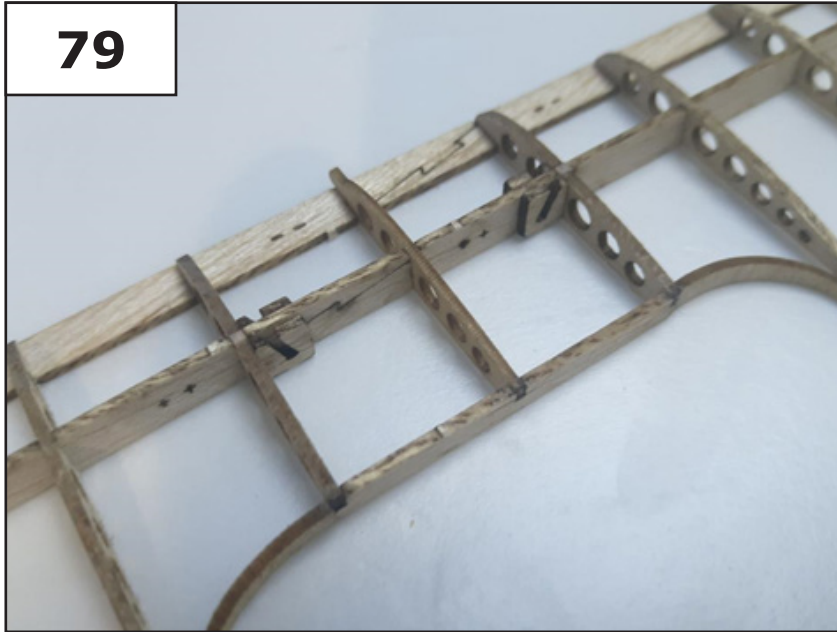

80

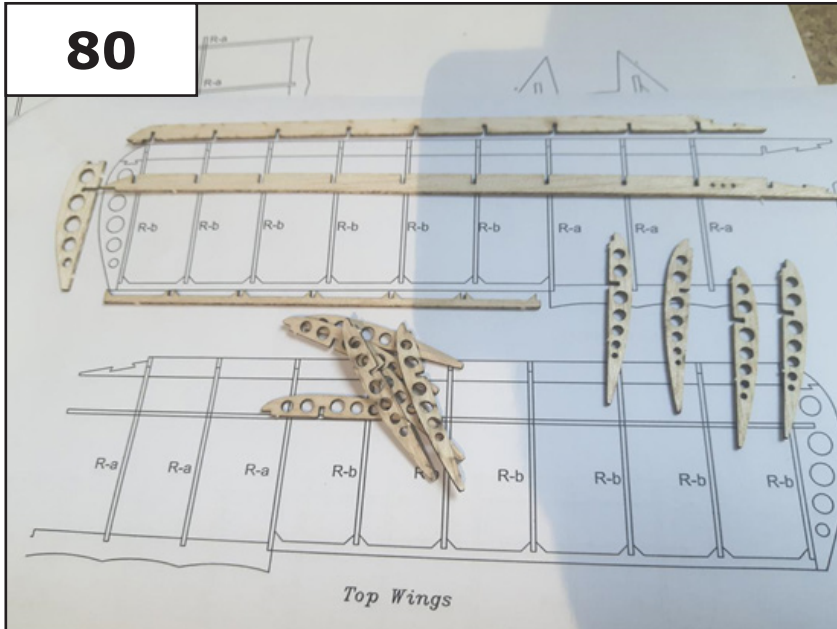

81

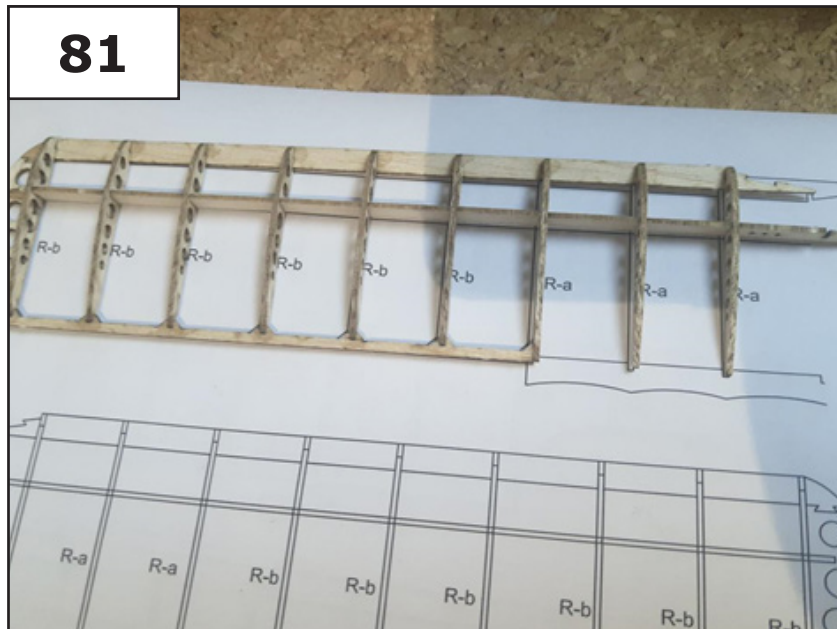

# Teil 1 - Rahmen

82

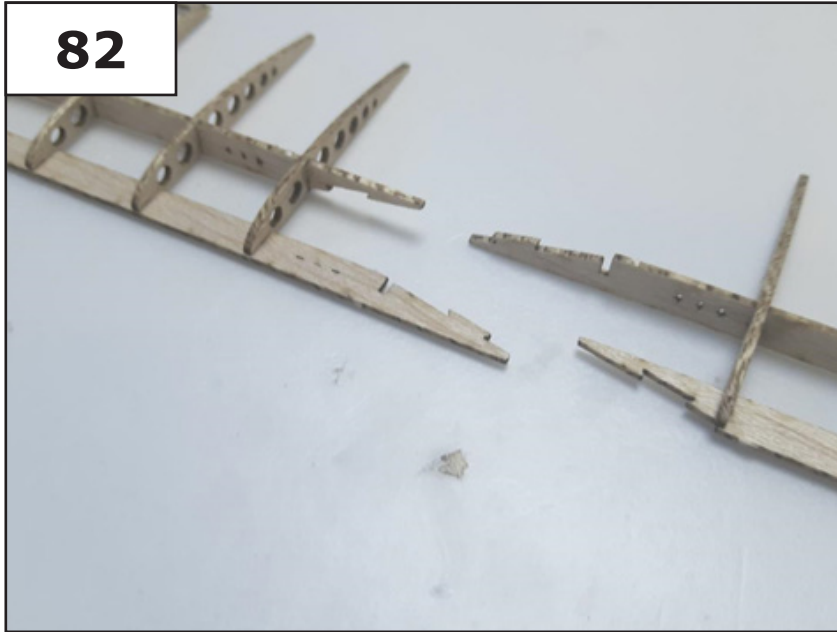

83

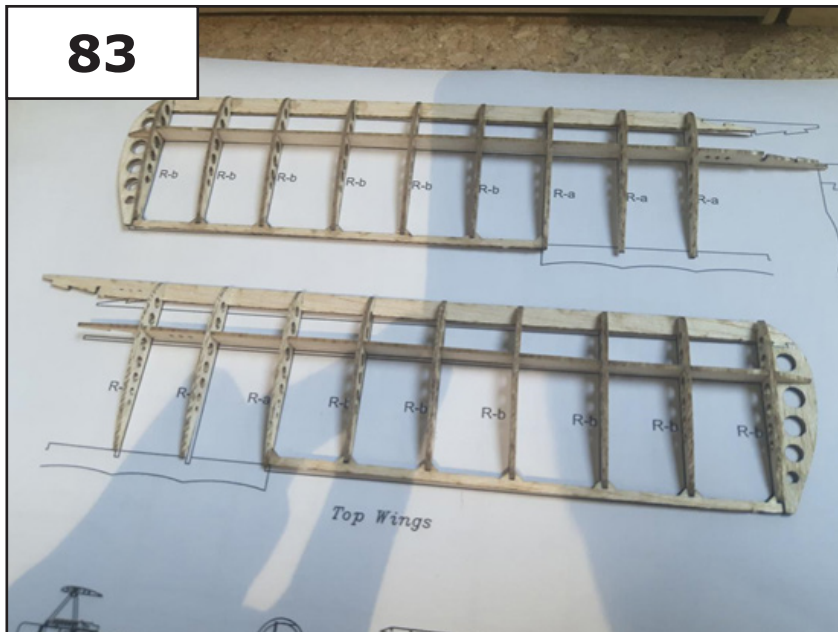

84

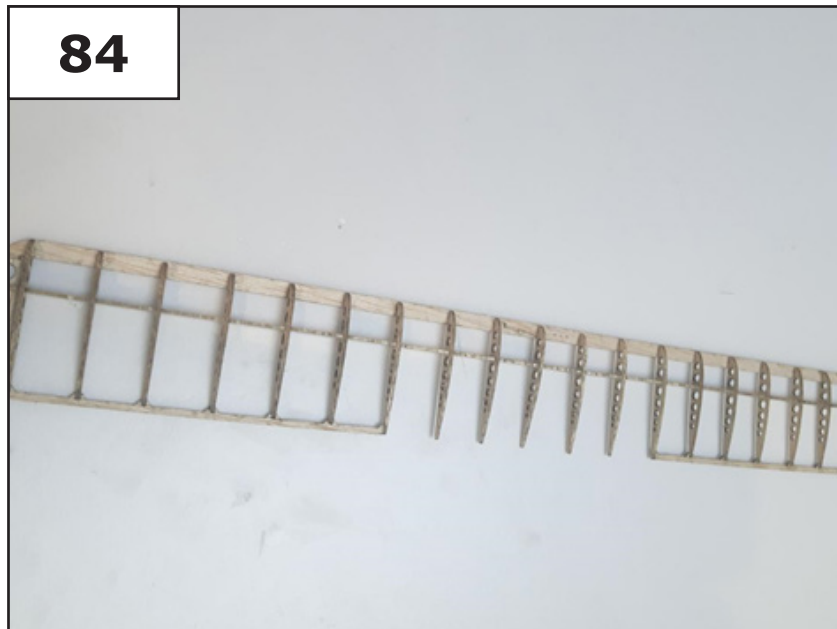

# Teil 1 - Rahmen

85

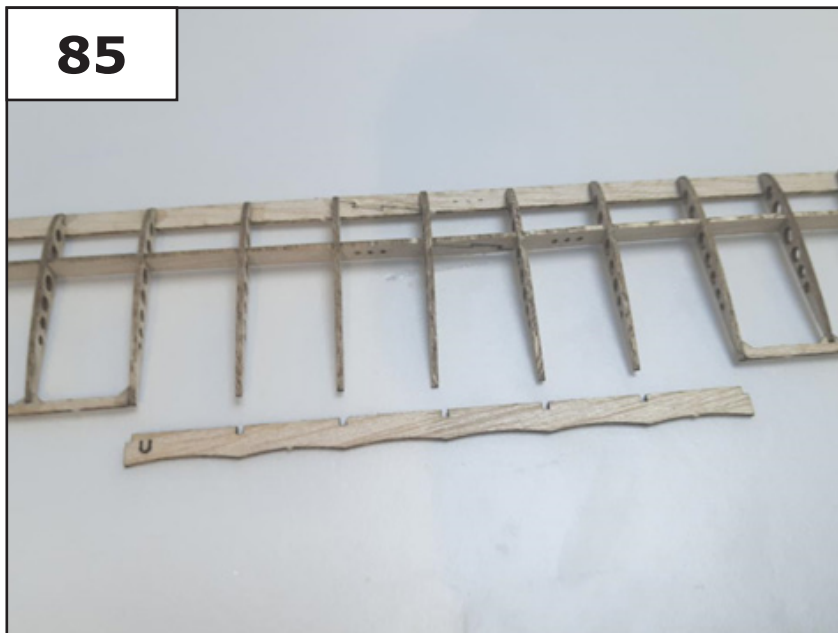

86

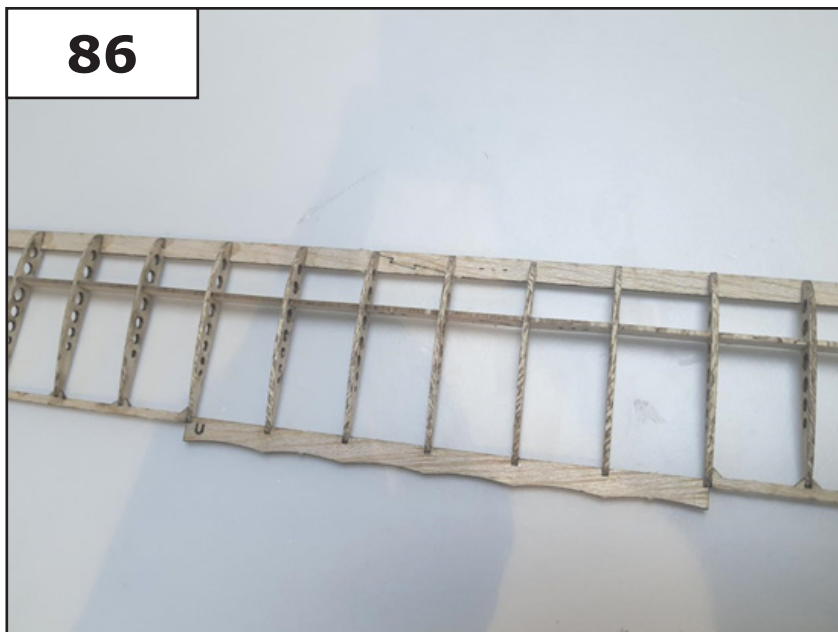

87

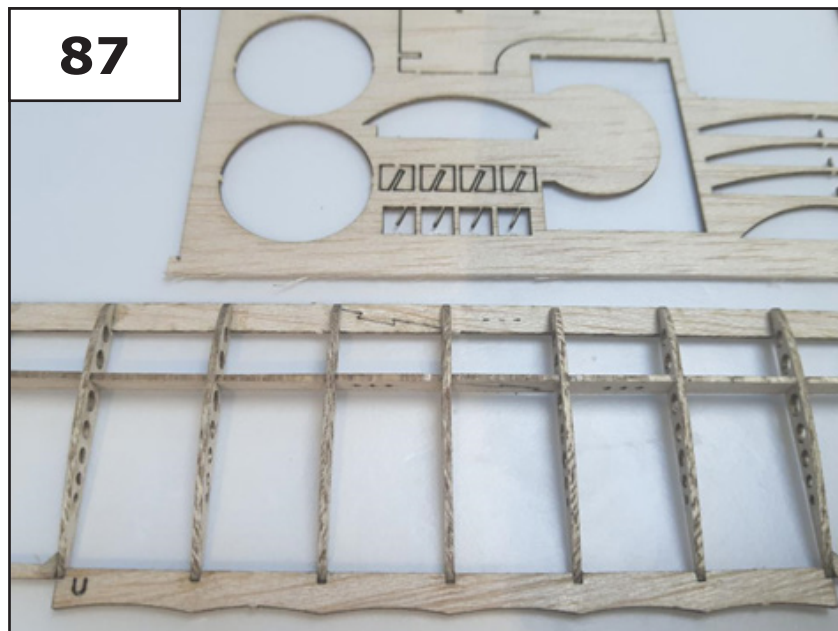

# Teil 1 - Rahmen

88

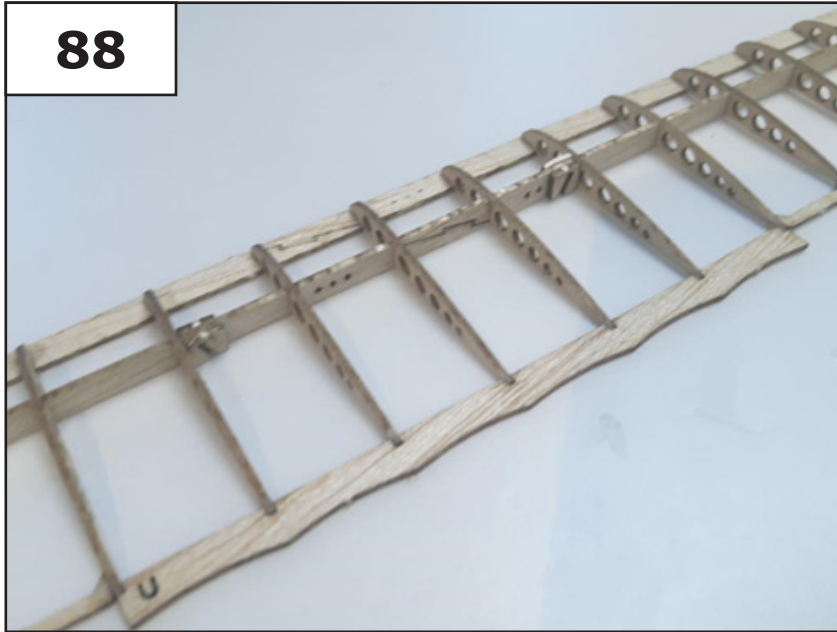

89

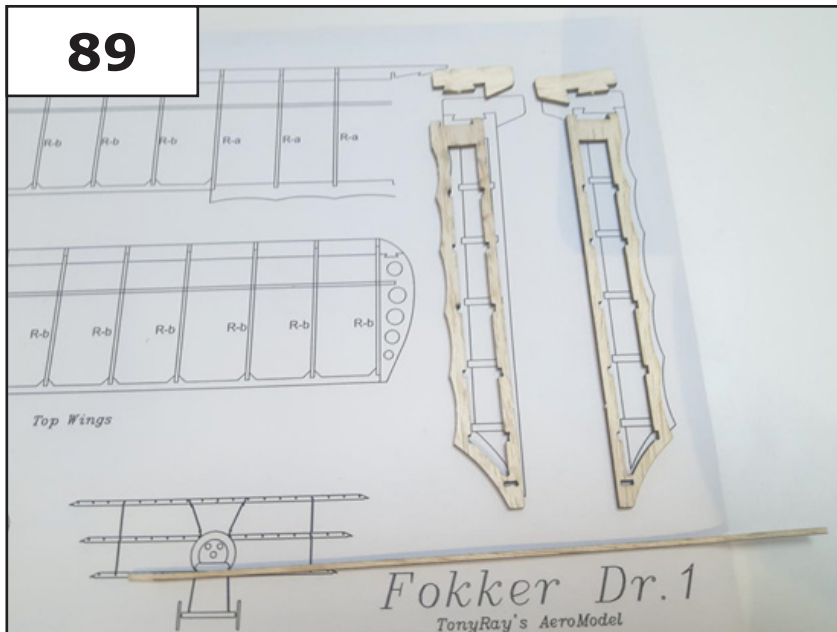

90

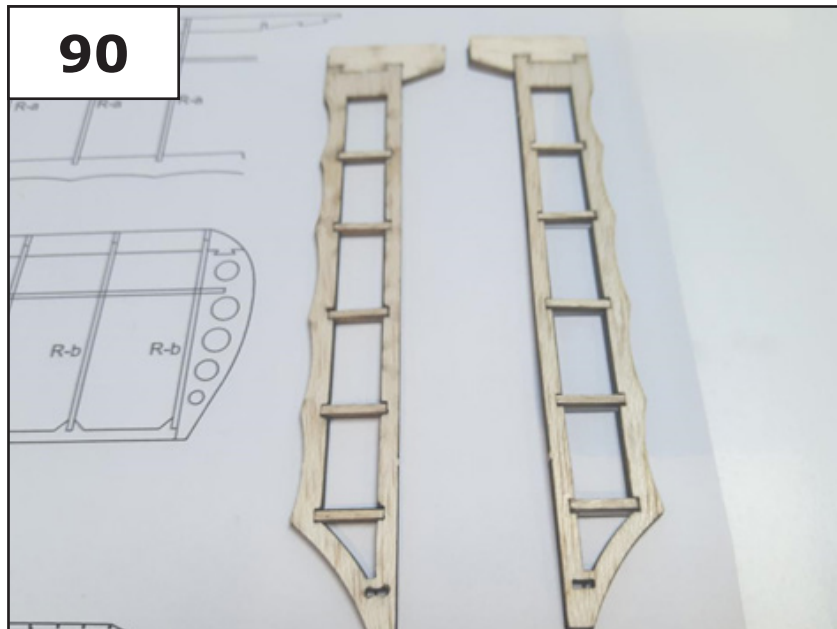

## Teil 1 - Rahmen

91

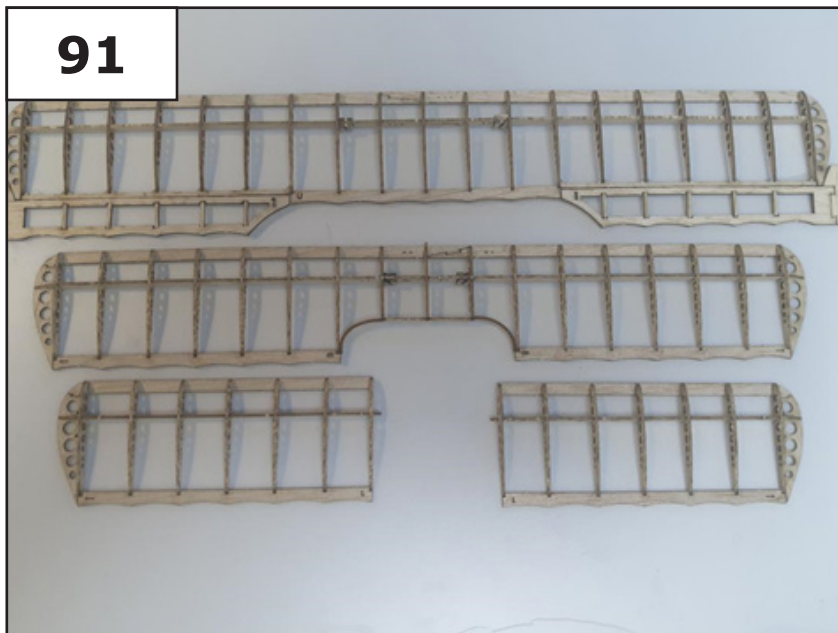

92

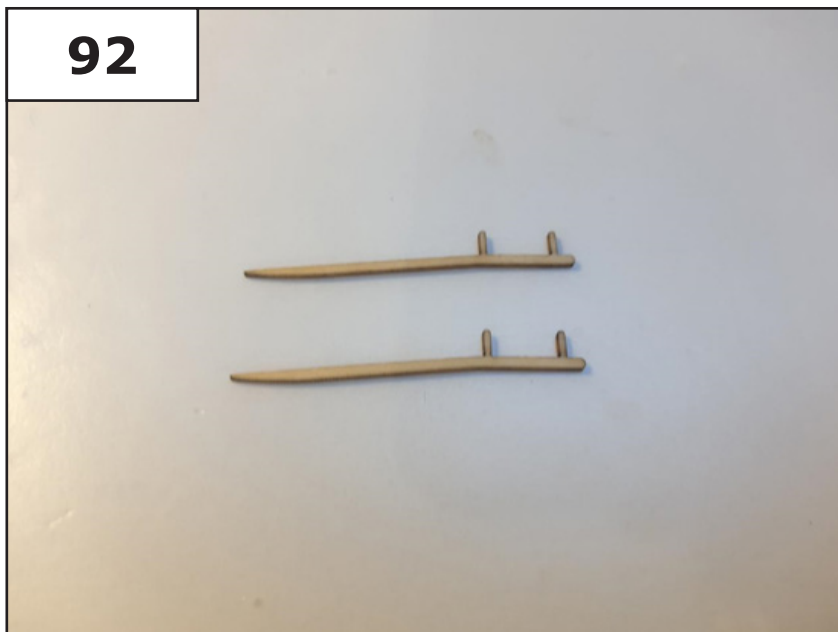

93

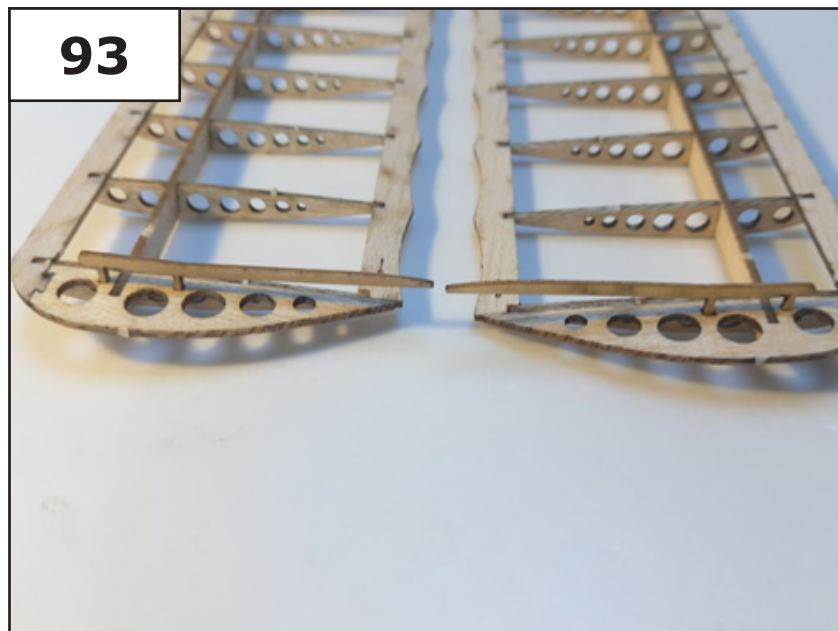



# Teil 1 - Rahmen

94

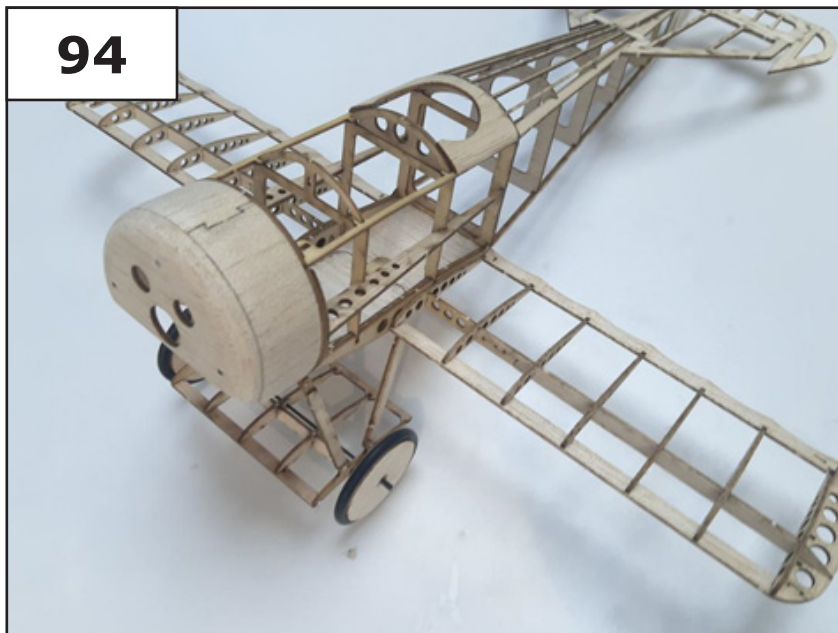

95

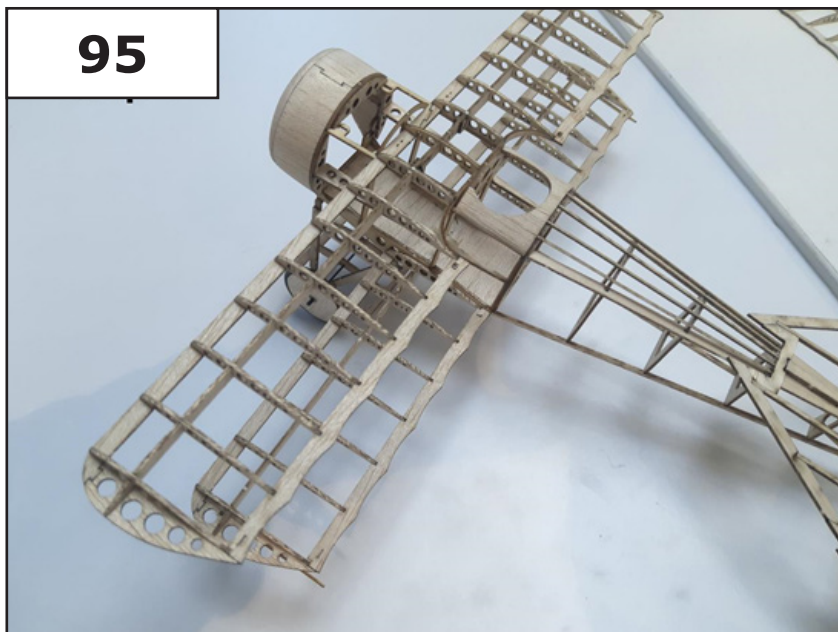

96

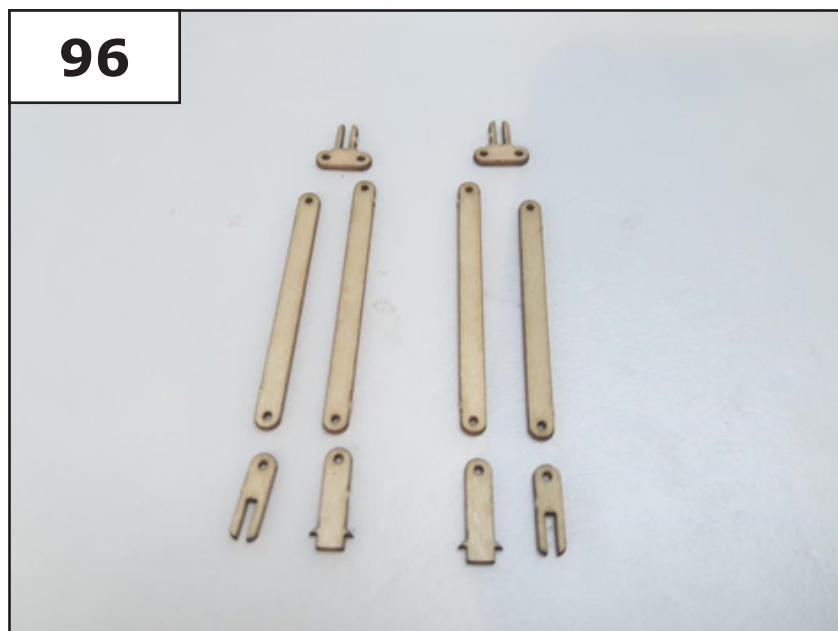

# Teil 1 - Rahmen

97

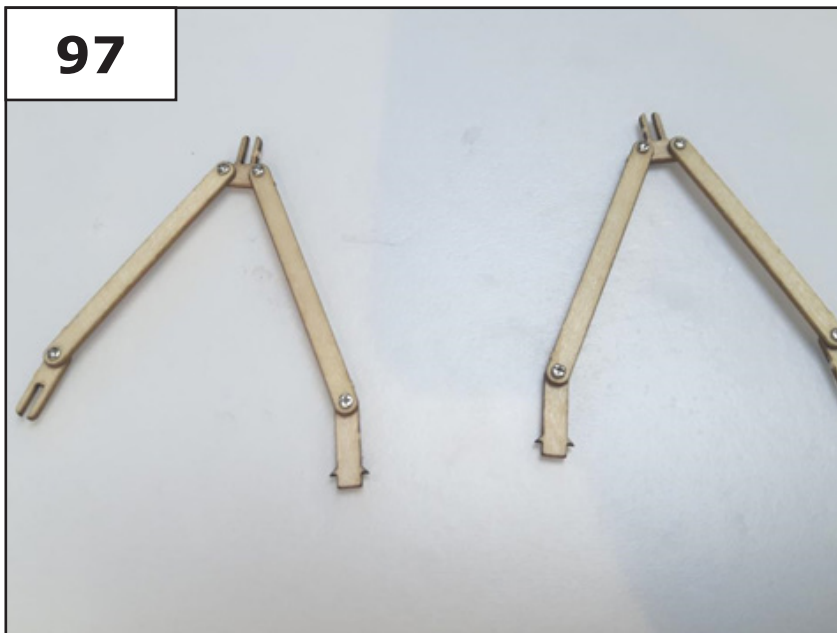

98

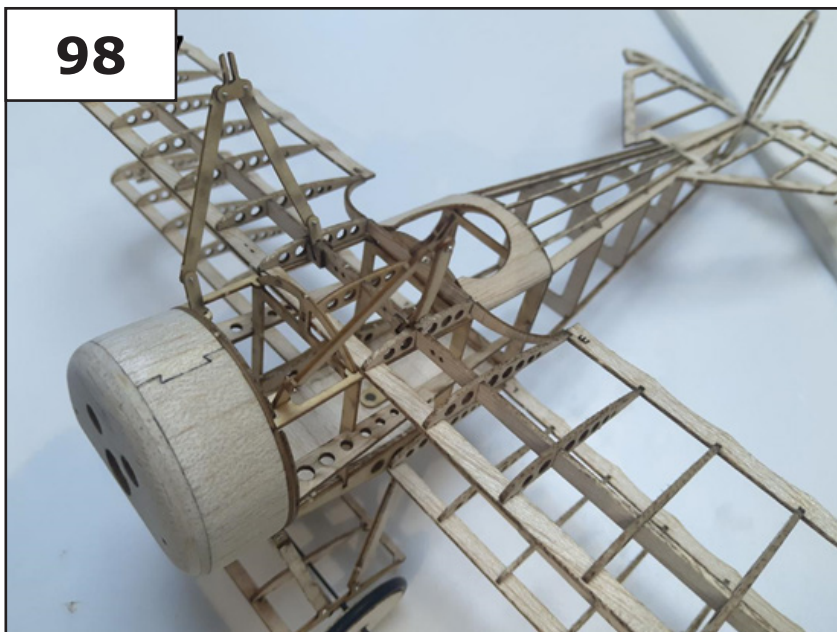

99



## Teil 1 - Rahmen

100

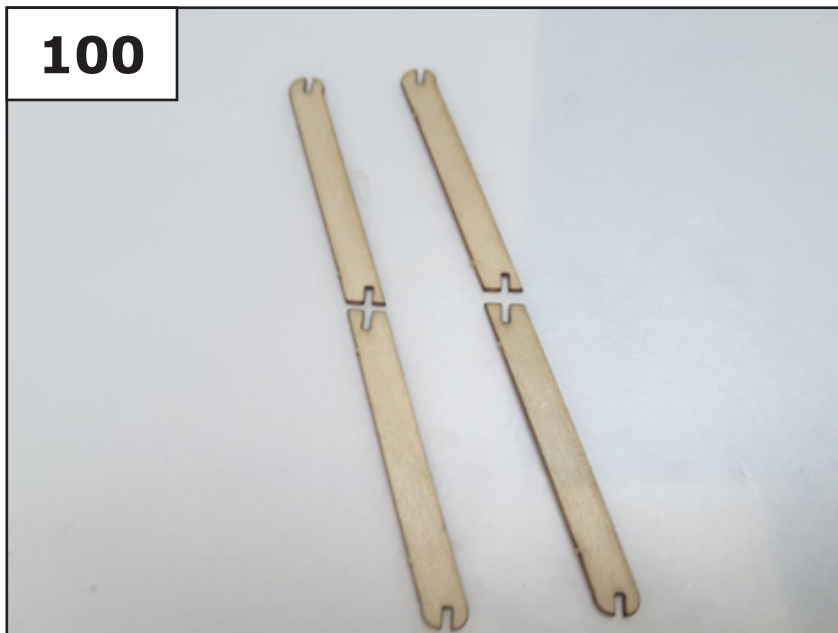

101

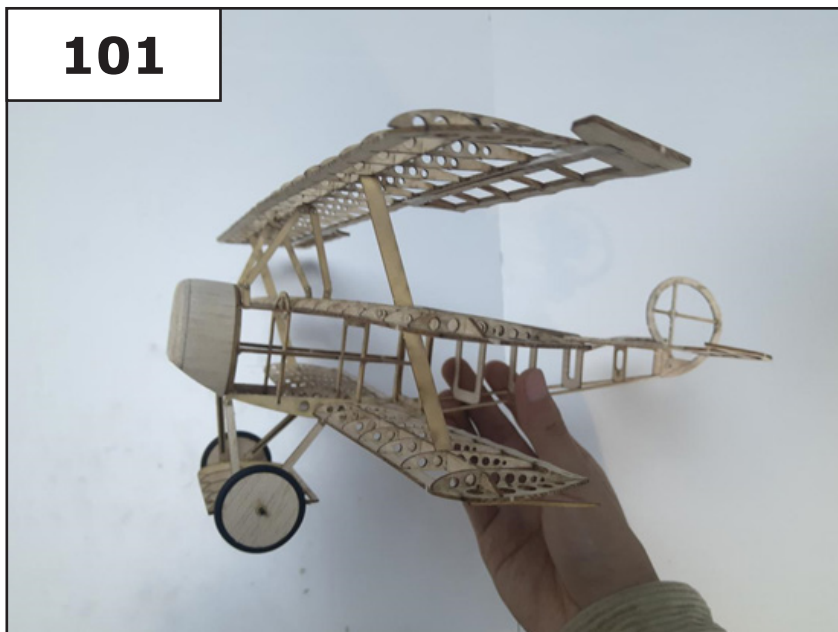

102

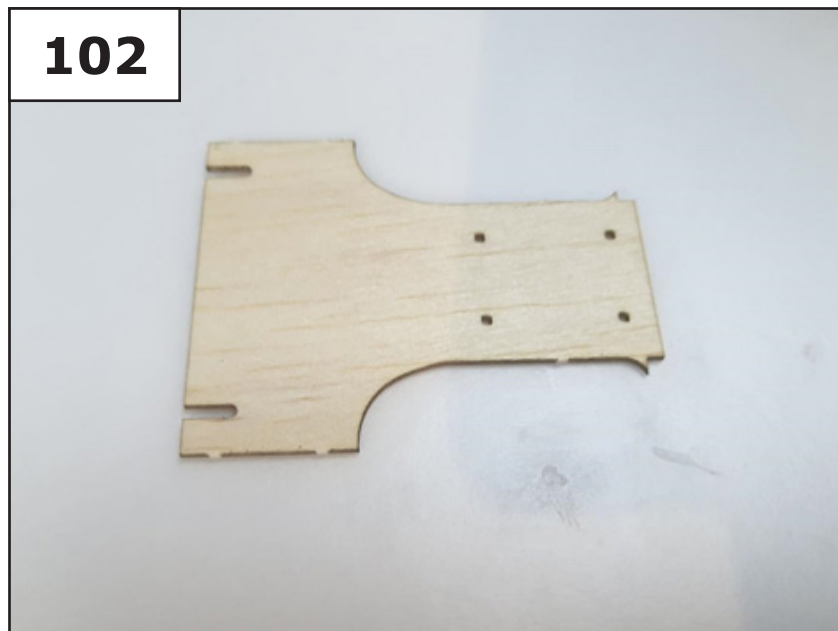

## Teil 1 - Rahmen

**103**

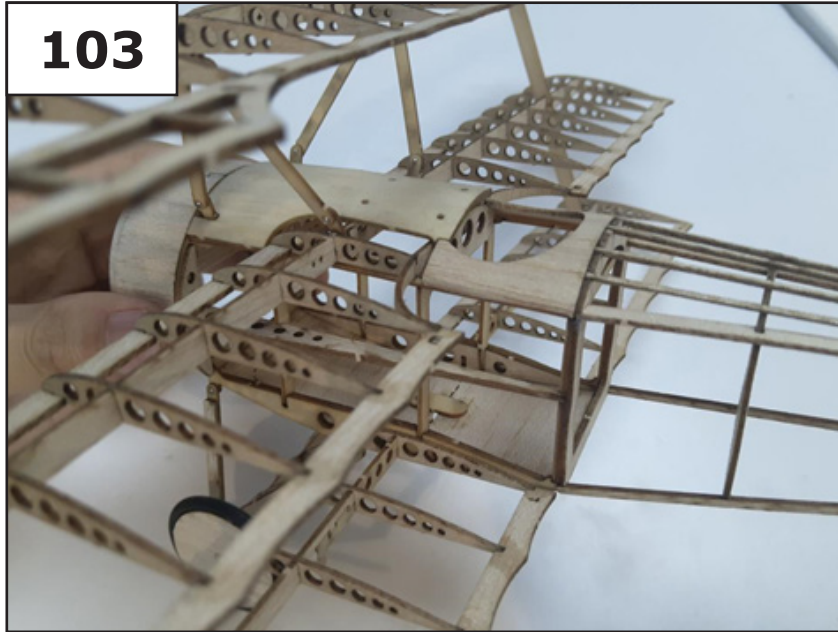

## Teil 2 - Zubehör

**1**

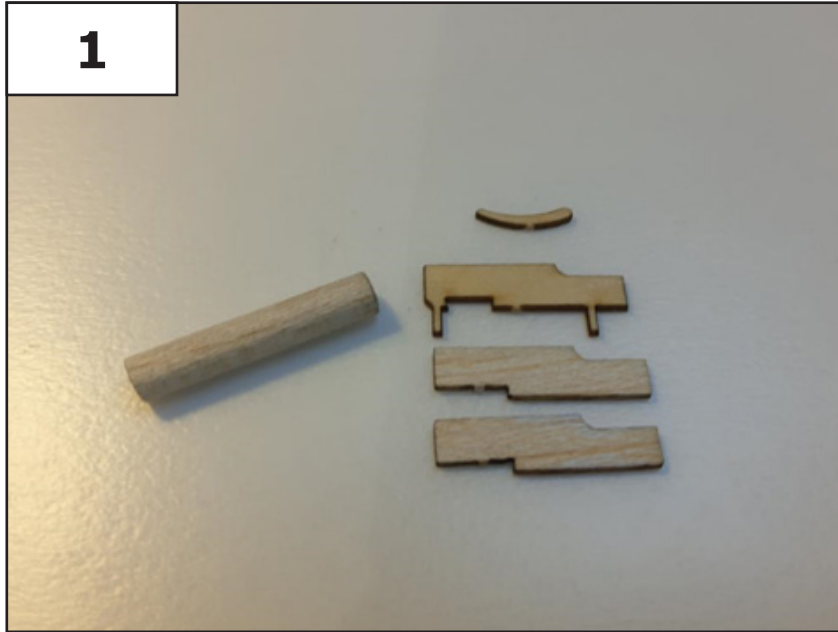

**2**

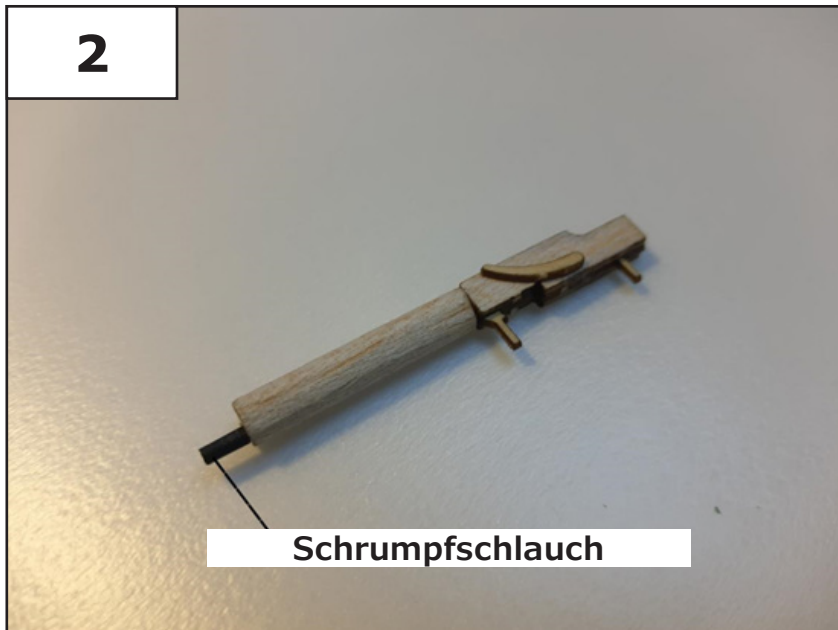

Schrumpfschlauch

**3**

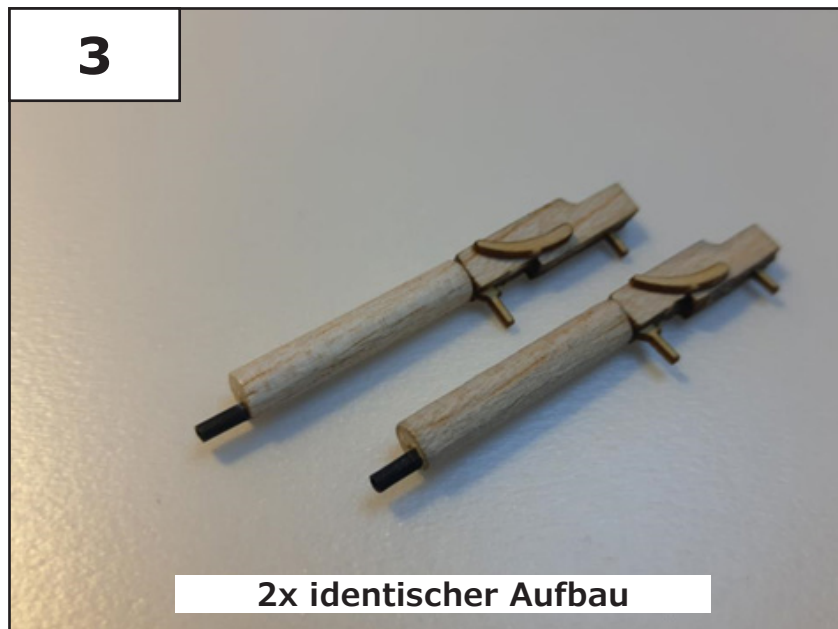

2x identischer Aufbau

## Teil 2 - Zubehör

4



5



6

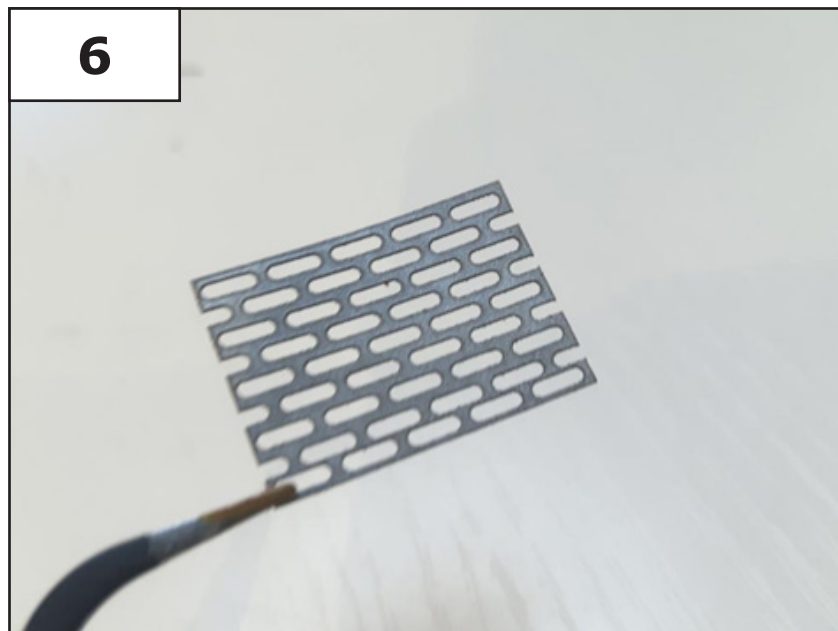

## Teil 2 - Zubehör

7

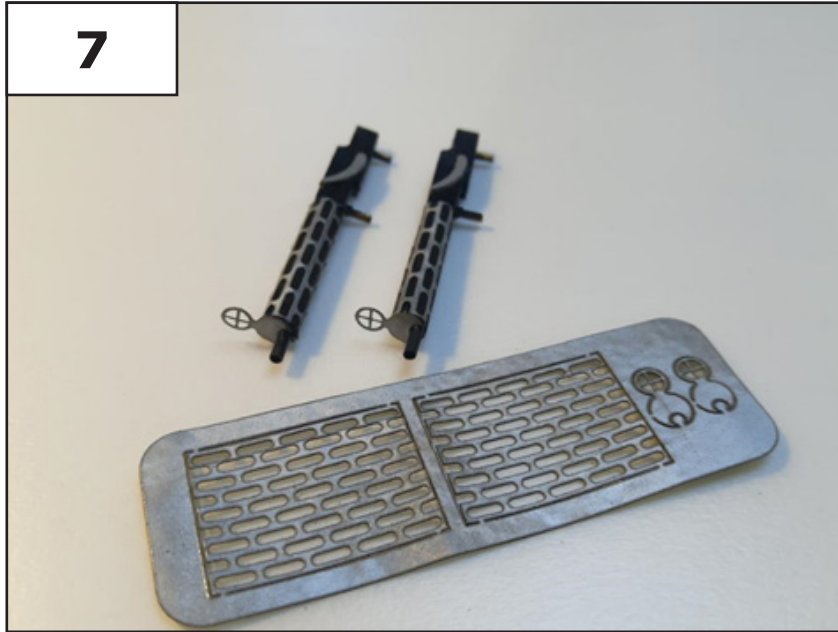

## Teil 3 - Elektronik

1



2

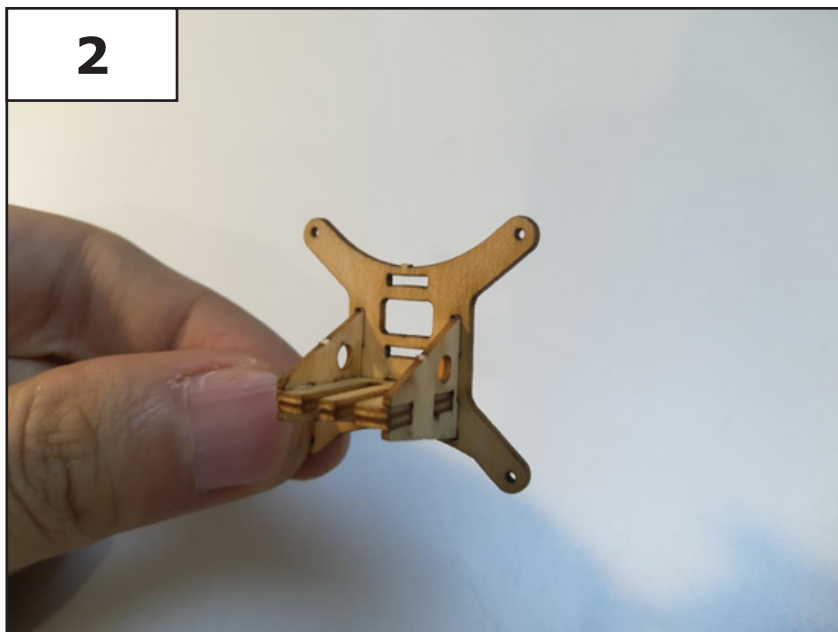

3

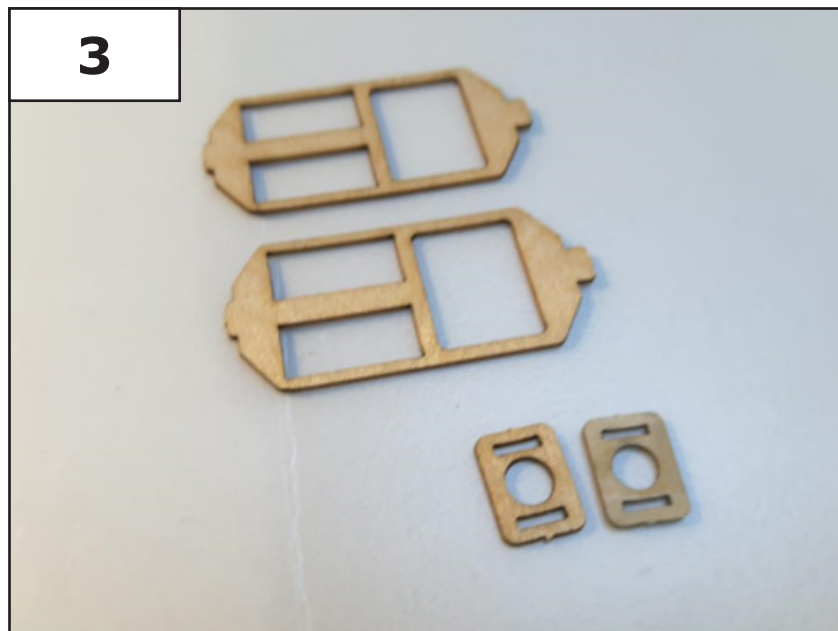



## Teil 3 - Elektronik

4

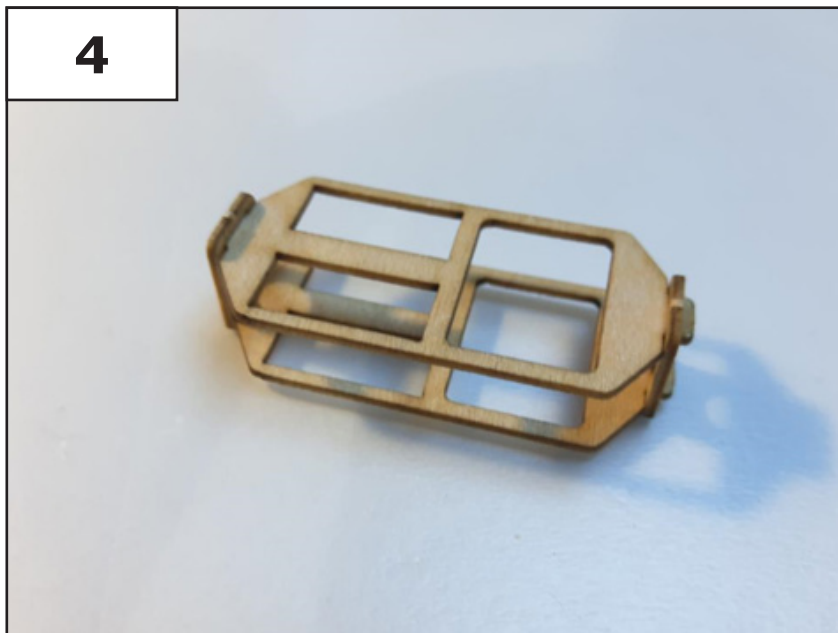

5

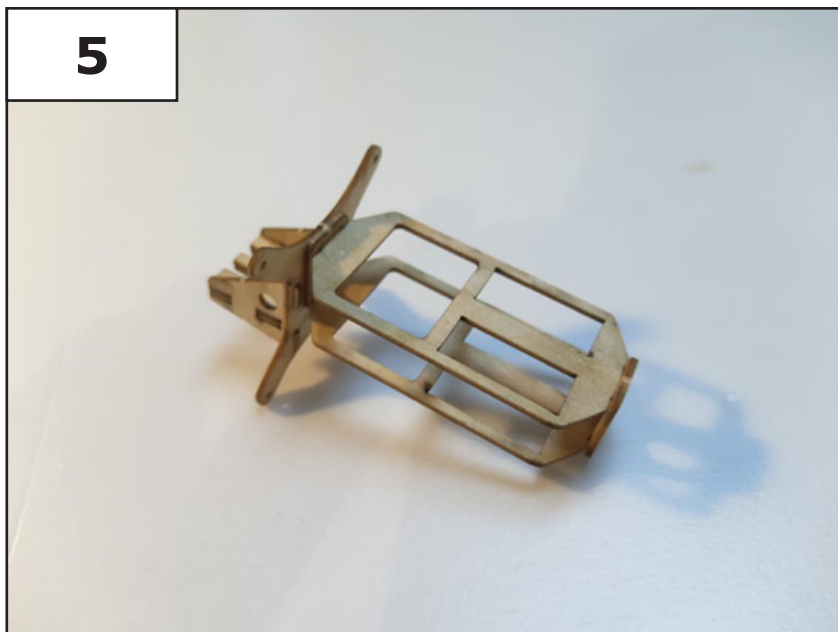

6

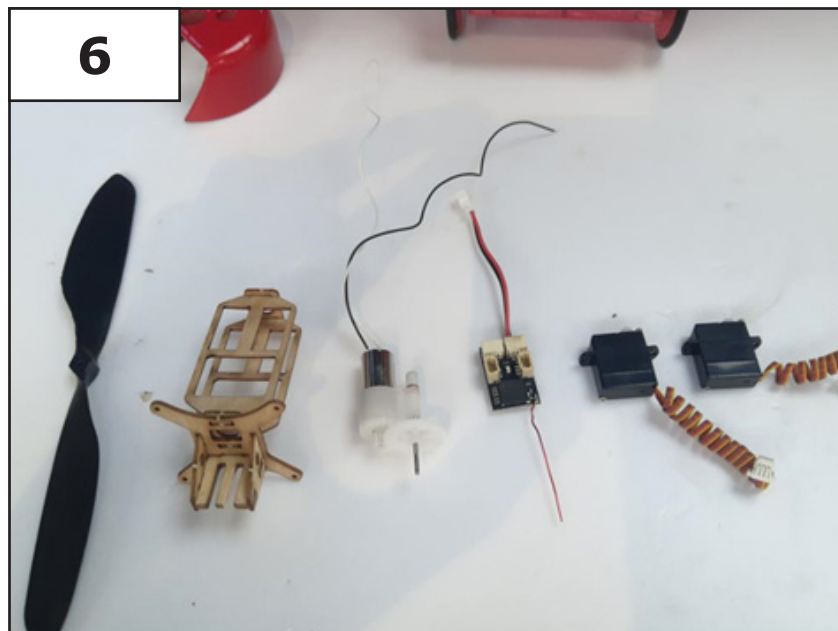

## Teil 3 - Elektronik

7

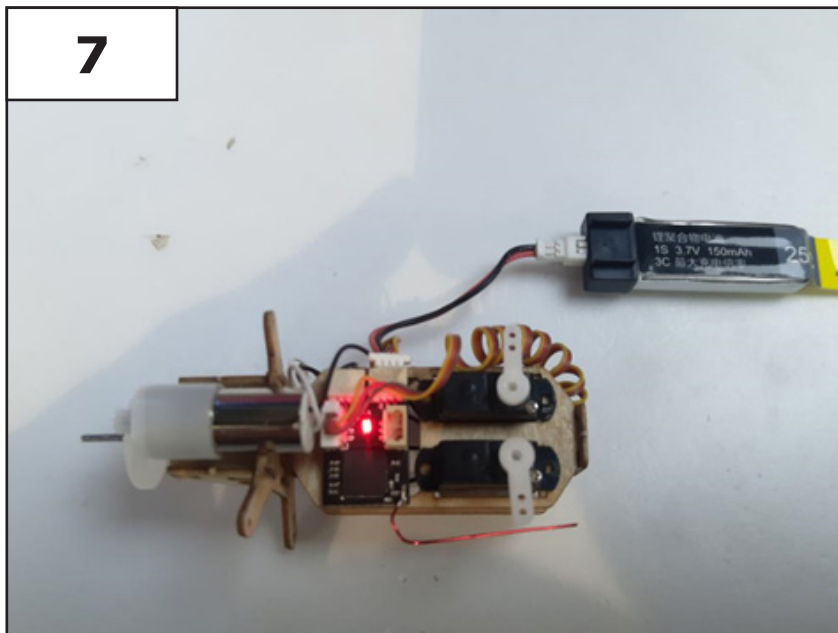

8

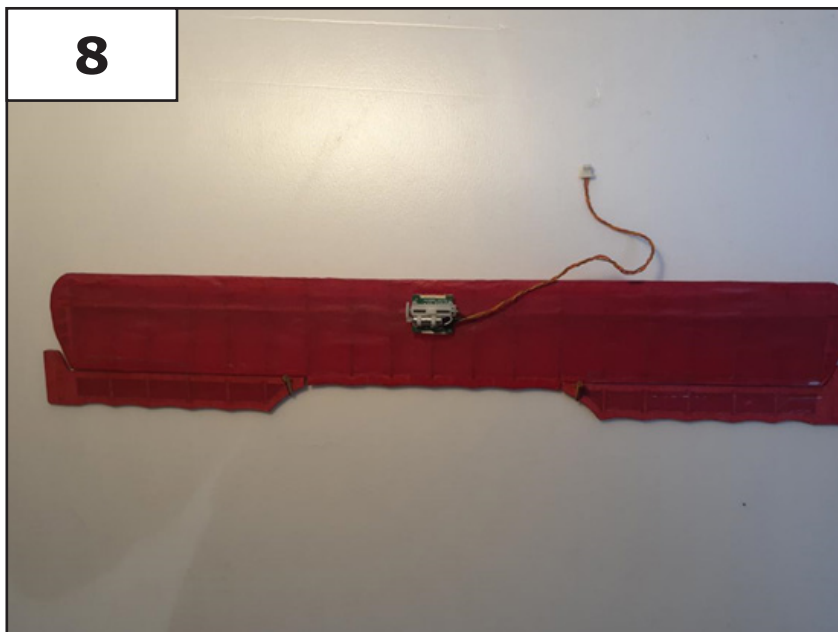

9

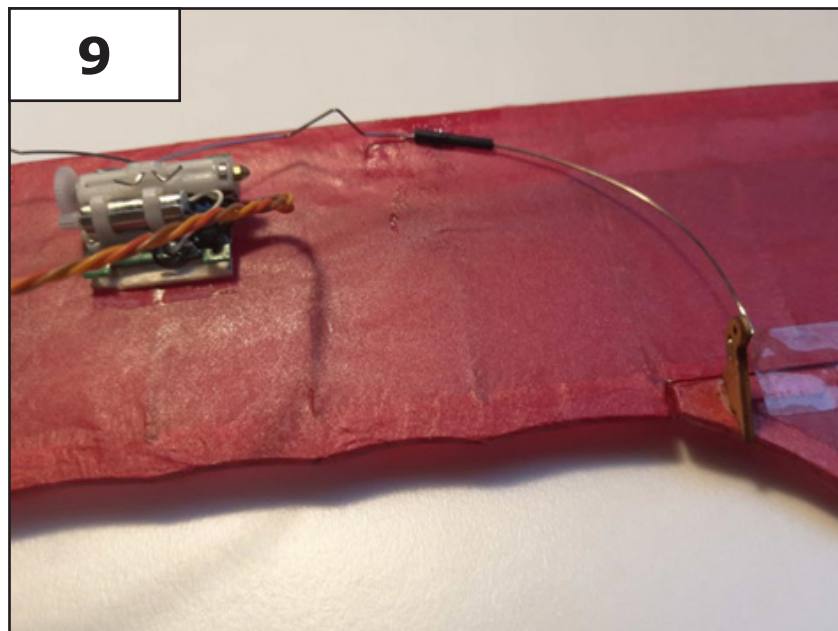

## Teil 3 - Elektronik

10



11

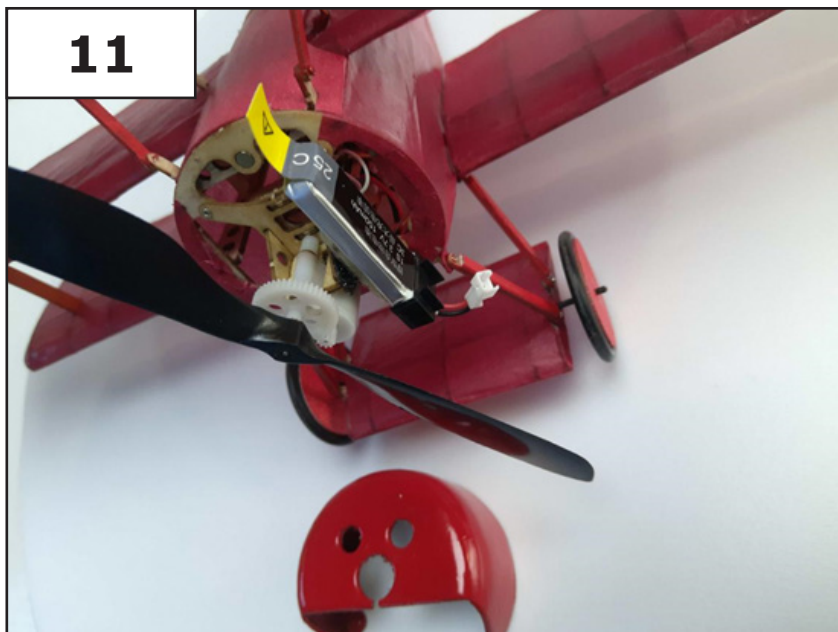

12



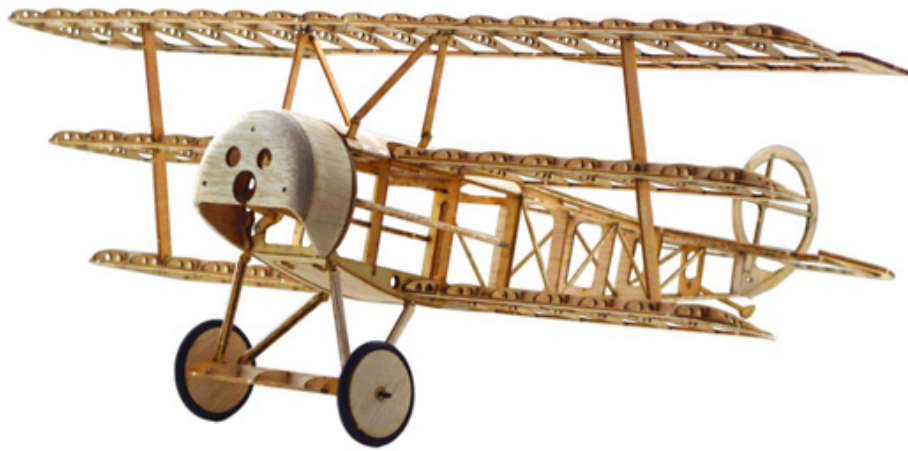

Den Rohbau des Modells haben Sie nun fertiggestellt.  
Für die Bespannung empfehlen wir JAPAN Air Bespannpapier aus unserem Shop.

[www.pichler.de](http://www.pichler.de)

Auf der Artikelseite finden Sie ebenfalls eine Anleitung wie Sie das Modell optimal bespannen können.



**PICHLER**

Pichler MODELLBAU GmbH  
Lauterbachstr. 19 | 84307 | Eggenfelden  
08721/508266-0 | mail@pichler.de