

Billig



Boats®

CARLI 236*

PHOTO MANUAL



DK CARLI

Baseret på et dansk fragtskib, bygget i 1902 i Svendborg med et andet navn. Fra 1933 til 1942 sejlede den under navnet "CARLI". I 1944 er undervejs fra Wismar til Odense, lastet med kul, ramte det en mine og gik ned. 2 af de 5 besætningsmedlemmer ombord overlevede.

GB CARLI

Based on a Danish freighter, build in 1902 in Svendborg with a different name. From 1933 to 1942 it sailed under the name "CARLI". In 1944 is while underway from Wismar to Odense, loaded with coal, it hit a mine and went down. 2 of the 5 crew members onboard survived.

D CARLI

Basierend auf einem dänischen Frachter, gebaut 1902 in Svendborg unter einem anderen Namen. Von 1933 bis 1942 fuhr es unter dem Namen „CARLI“. Im Jahr 1944 stieß es auf der Fahrt von Wismar nach Odense, beladen mit Kohle, auf eine Mine und stürzte ab. Zwei der fünf Besatzungsmitglieder an Bord überlebten.

F CARLI

Basé sur un cargo danois, construit en 1902 à Svendborg sous un nom différent. De 1933 à 1942, il a navigué sous le nom de « CARLI ». En 1944, alors qu'il était en route de Wismar à Odense, chargé de charbon, il heurta une mine et tomba en panne. 2 des 5 membres d'équipage à bord ont survécu.

NL CARLI

Gebaseerd op een Deens vrachtschip, gebouwd in 1902 in Svendborg met een andere naam. Van 1933 tot 1942 voer het onder de naam "CARLI". In 1944, terwijl het onderweg was van Wismar naar Odense, beladen met steenkool, raakte het een mijn en stortte in. Twee van de vijf bemanningsleden aan boord hebben het overleefd.

E CARLI

Basado en un carguero danés construido en 1902 en Svendborg con otro nombre. De 1933 a 1942 navegó con el nombre de "CARLI". En 1944, mientras navegaba de Wismar a Odense, cargado de carbón, chocó contra una mina y se hundió. 2 de los 5 tripulantes a bordo sobrevivieron.

I CARLI

Basato su un mercantile danese, costruito nel 1902 a Svendborg con un nome diverso. Dal 1933 al 1942 navigò con il nome "CARLI". Nel 1944 mentre era in viaggio da Wismar a Odense, carico di carbone, colpì una mina e precipitò. 2 dei 5 membri dell'equipaggio a bordo sono sopravvissuti.

P CARLI

Baseado num cargueiro dinamarquês, construído em 1902 em Svendborg com um nome diferente. De 1933 a 1942 navegou com o nome "CARLI". Em 1944, enquanto viajava de Wismar para Odense, carregado de carvão, atingiu uma mina e afundou. 2 dos 5 tripulantes a bordo sobreviveram.

PL CARLI

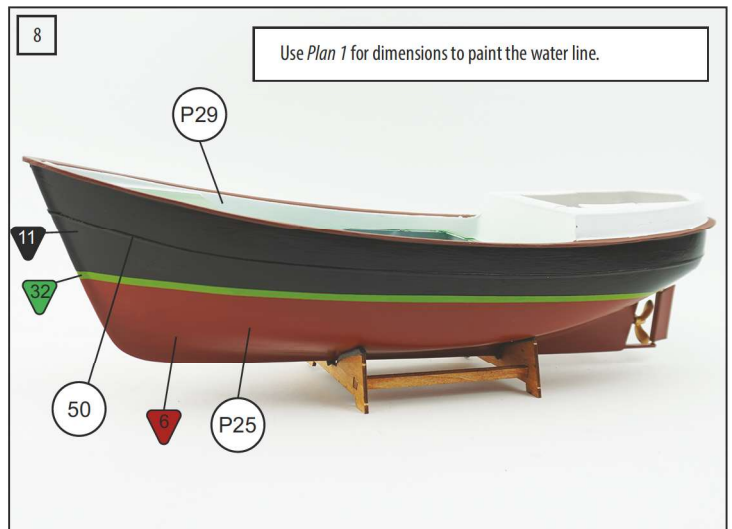
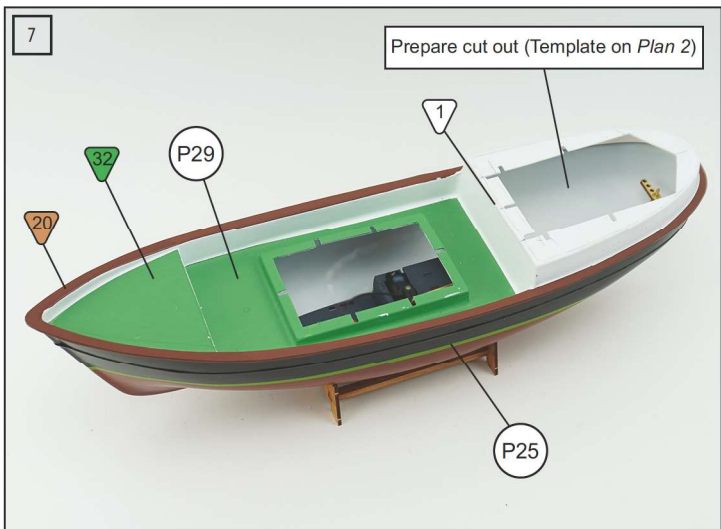
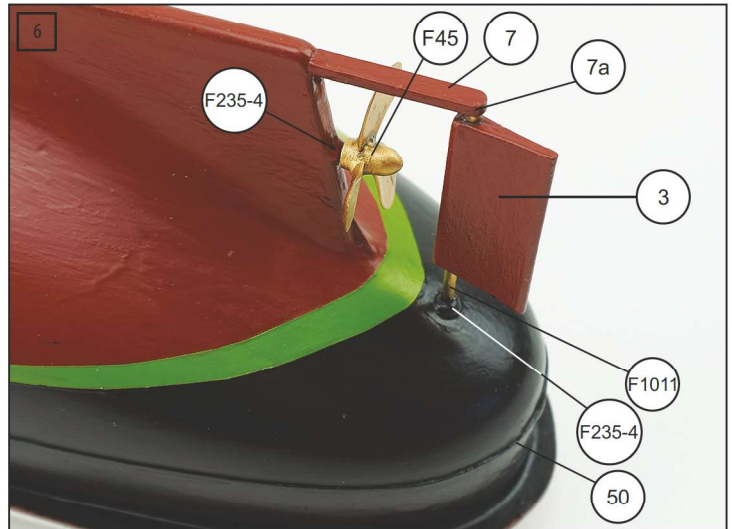
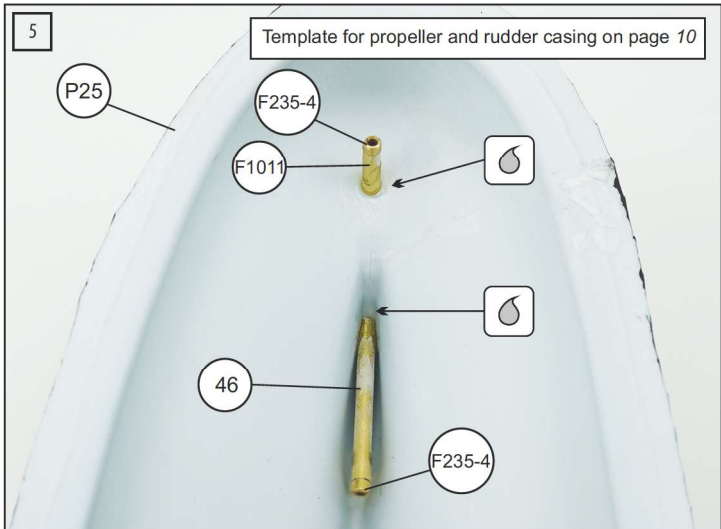
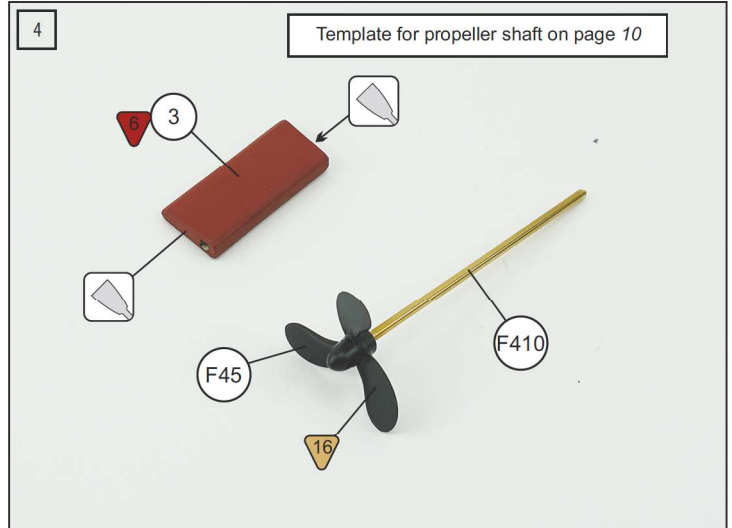
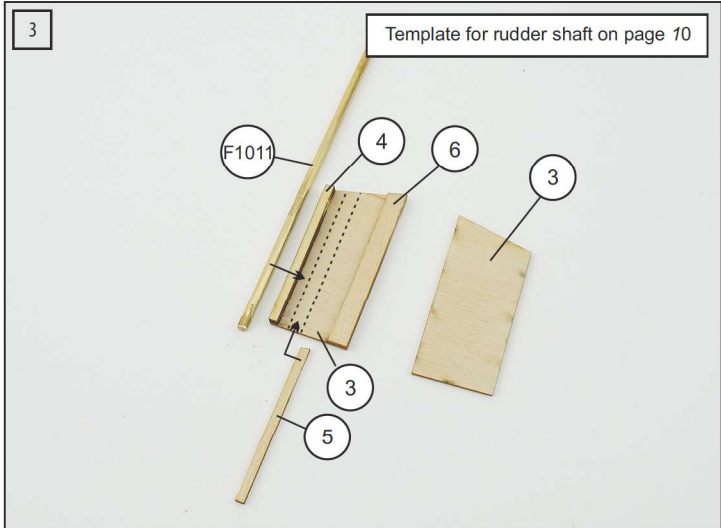
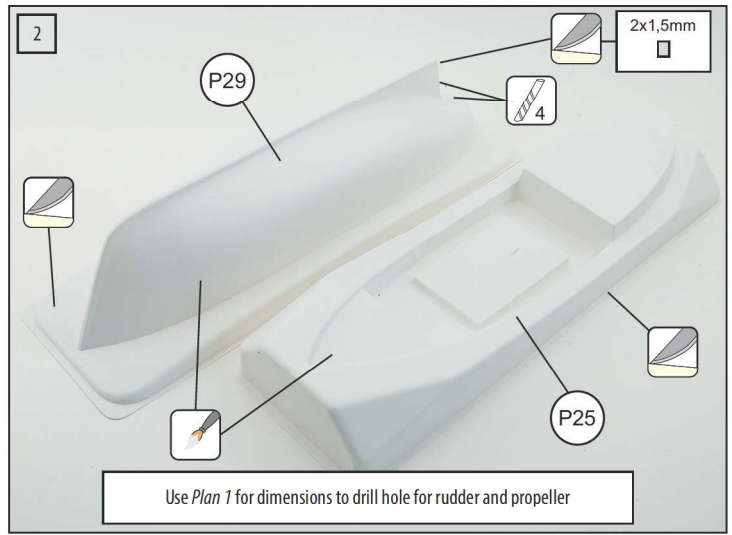
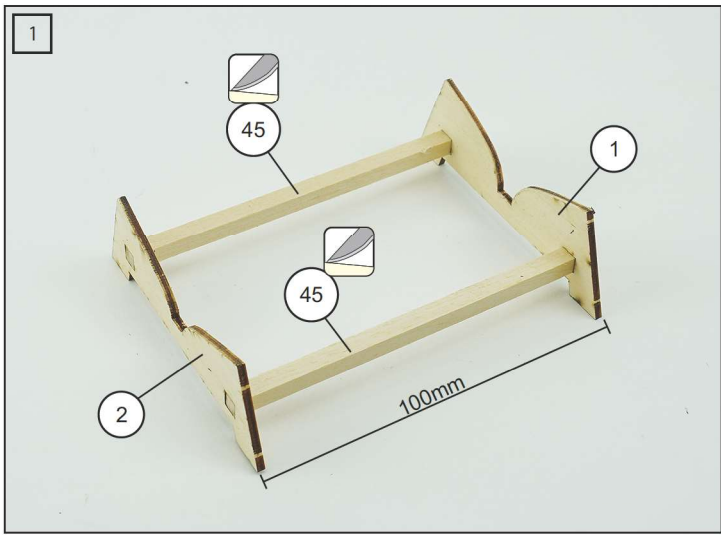
Wzorowany na duńskim frachtowcu, zbudowanym w 1902 roku w Svendborgu pod inną nazwą. Od 1933 do 1942 roku pływał pod nazwą „CARLI”. W 1944 r., w drodze z Wismaru do Odense, załadowany węglem, uderzył w minę i zatonął. 2 z 5 członków załogi na pokładzie przeżyło.

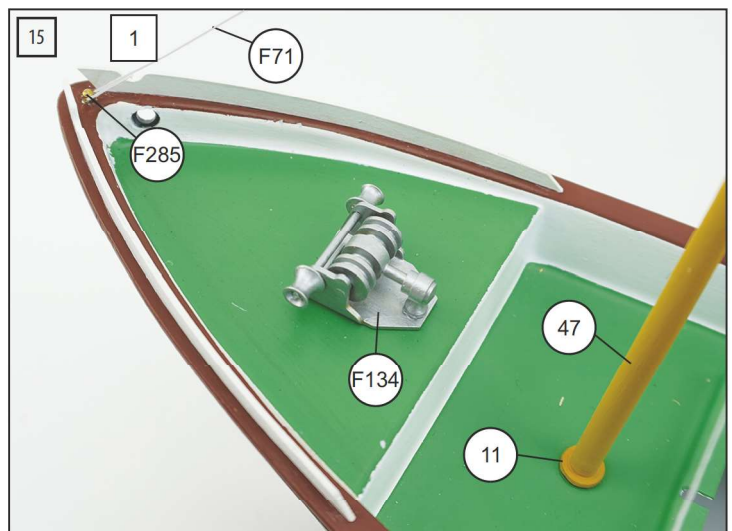
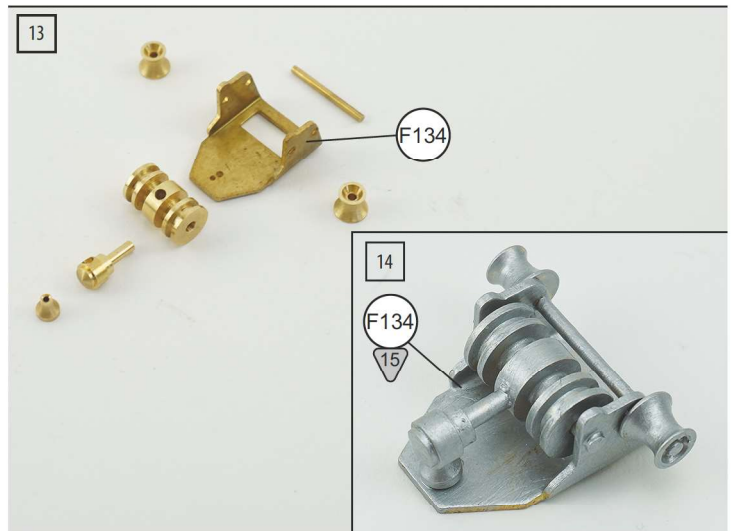
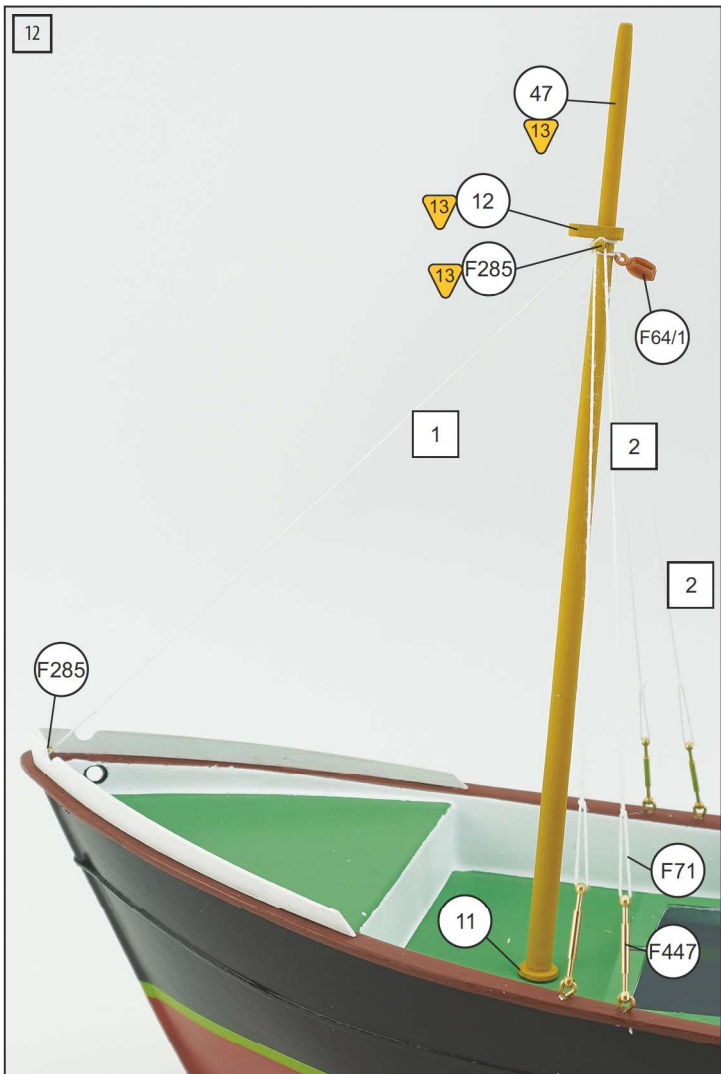
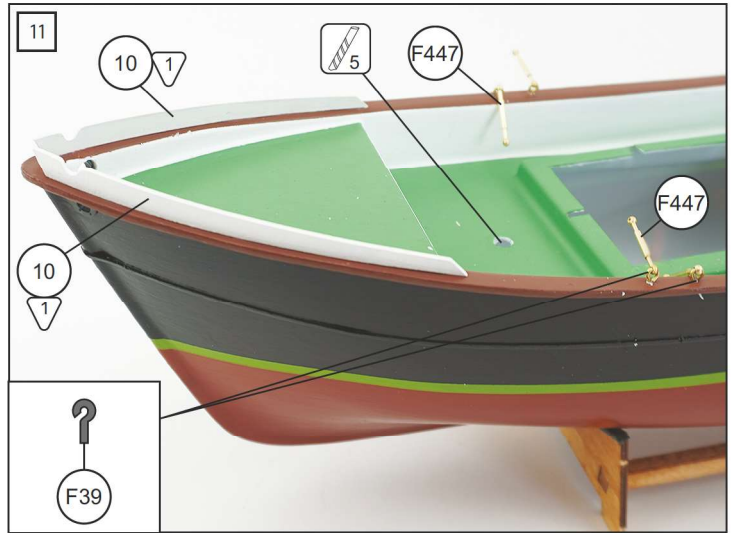
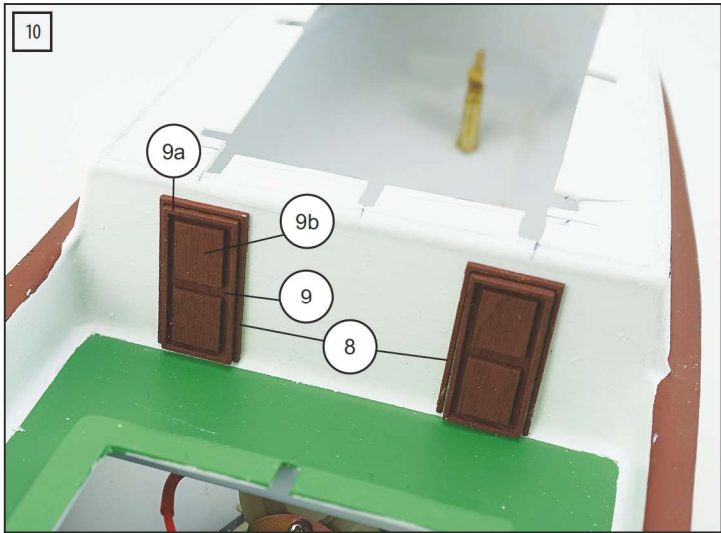
To see our color conversion chart please visit <https://www.billingboats.com/faq>

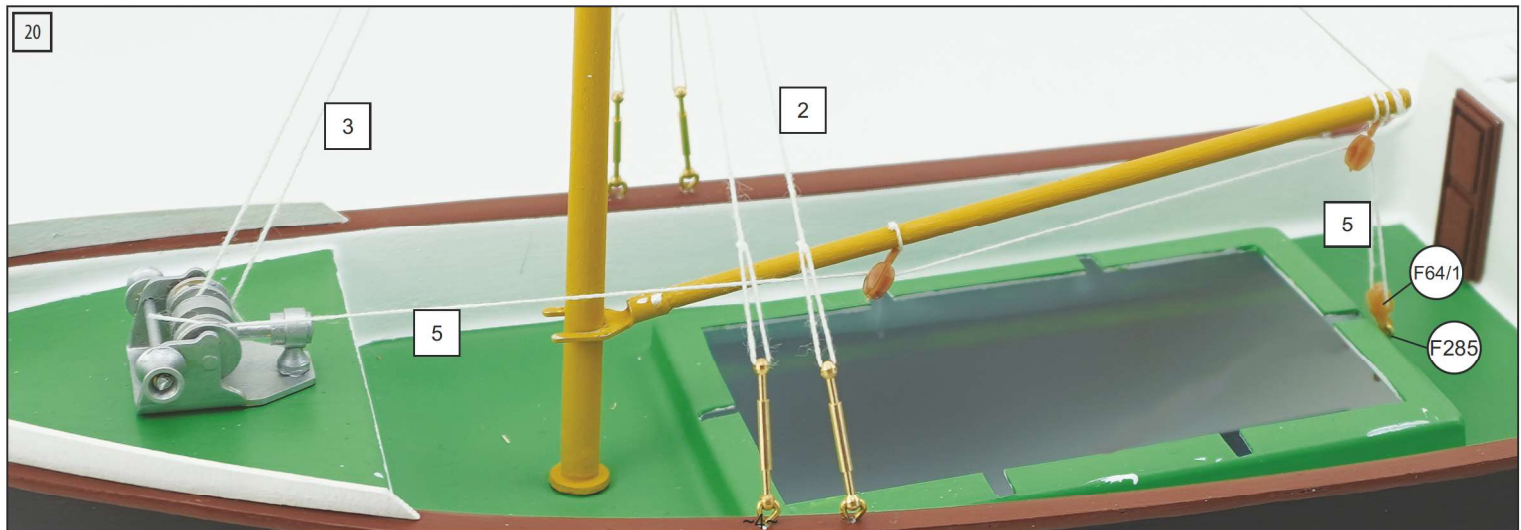
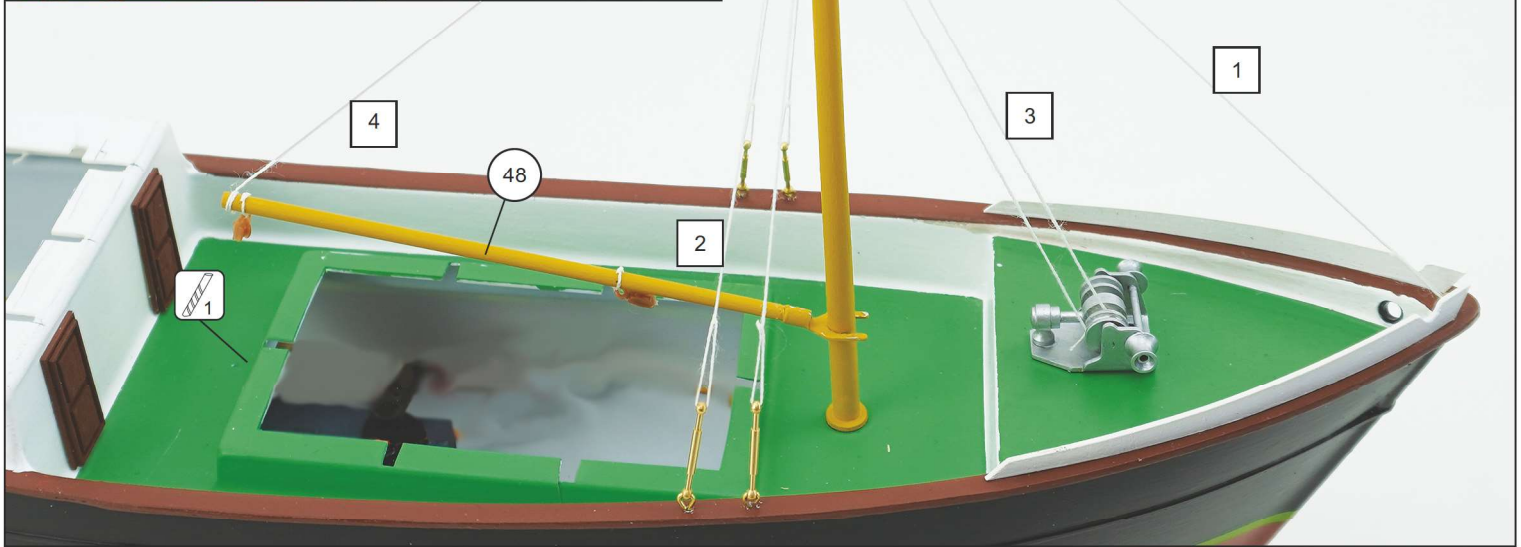
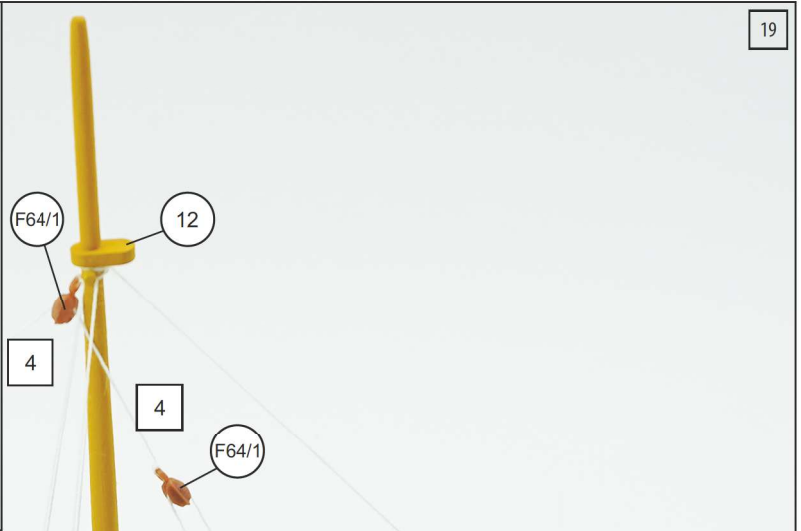
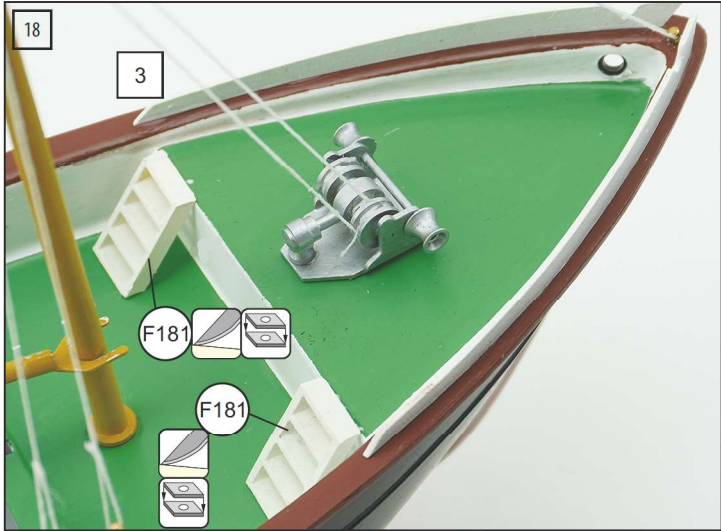
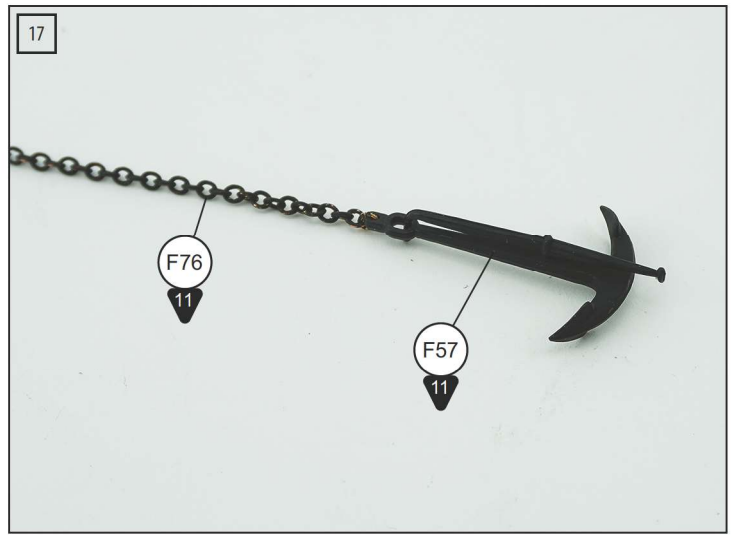
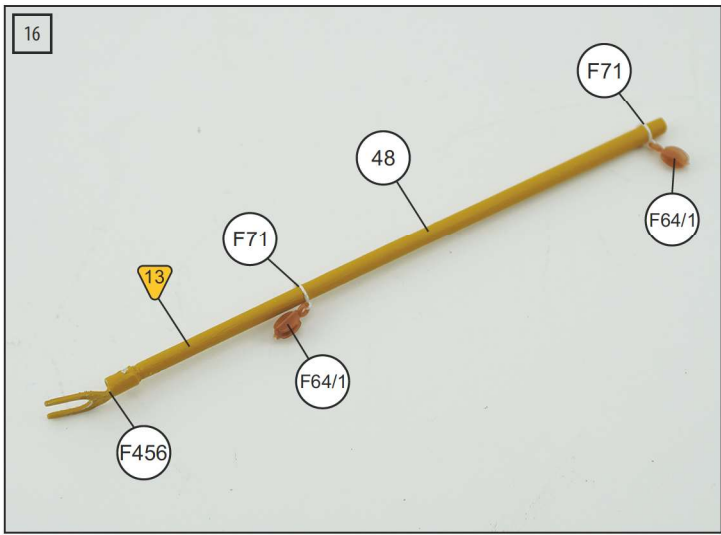
Til denne model er mahogni bejdse og farver med følgende numre nødvendige:
 For this model is mahogany stain and colours with the following numbers should be used:
 Für dieses Modell sind Mahagoni Beize und Farben mit den folgenden Nummern notwendig:
 Pour ce modèle, le mordant et les couleurs avec les numéros suivants doivent être employées:
 Voor dit model zijn kleuren met de volgende nummers nodig:
 Para est modelo se necesitan mordiente et colores con los siguientes números:
 Per questo modello occorrono inchiostro tinteggiatore "mogano" e colori con questi numeri:
 Pinte o modelo com tintura cor Mogno e as cores sugeridas da Billing Boats:
 W przypadku tego modelu należy użyć bejcy mahoniowej oraz farby o numerach:

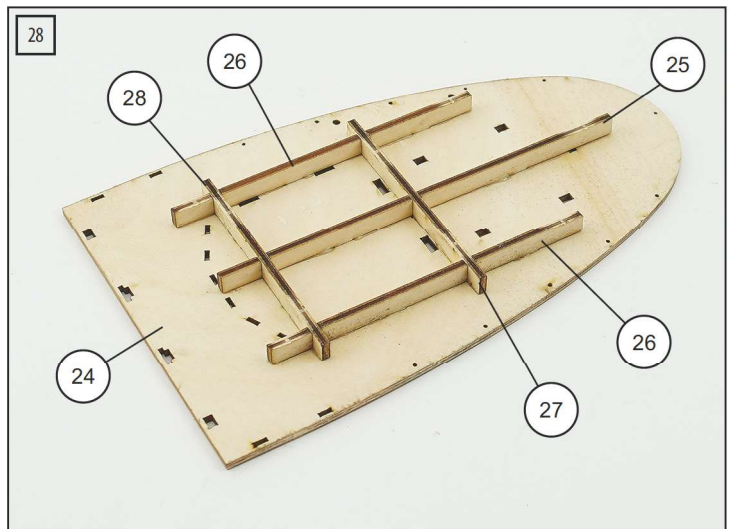
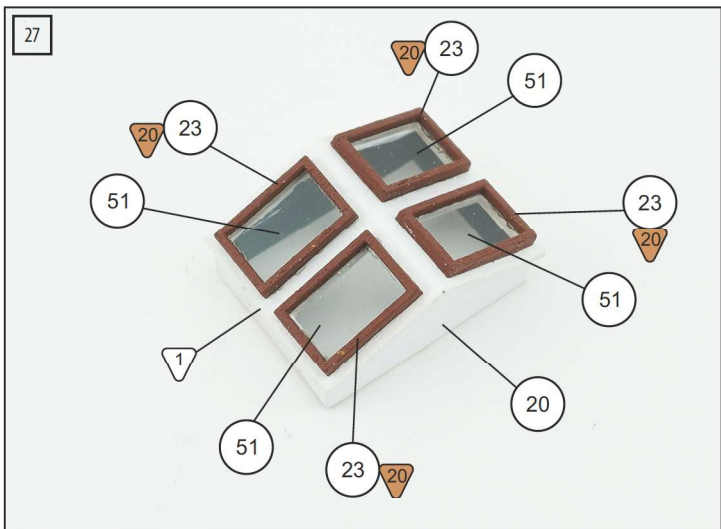
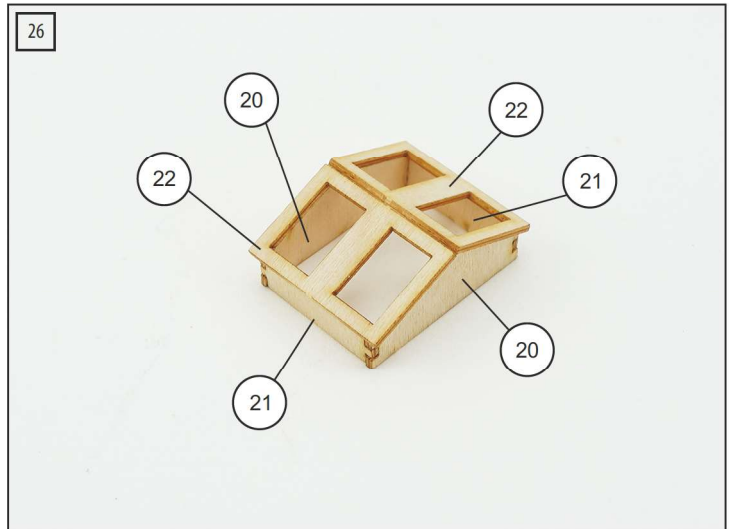
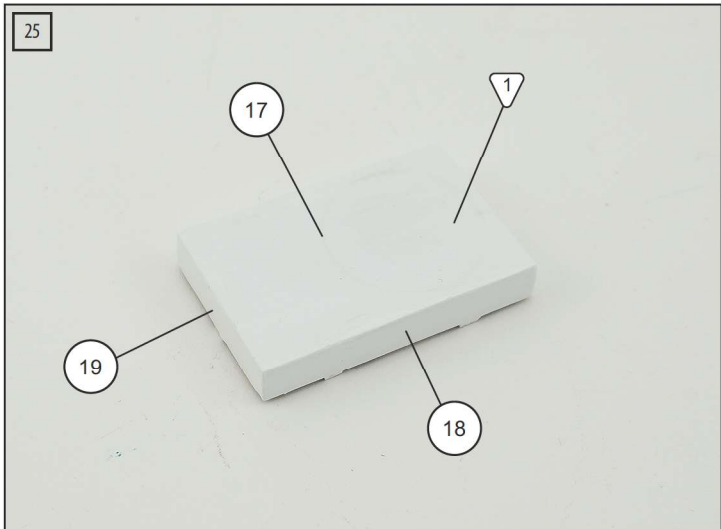
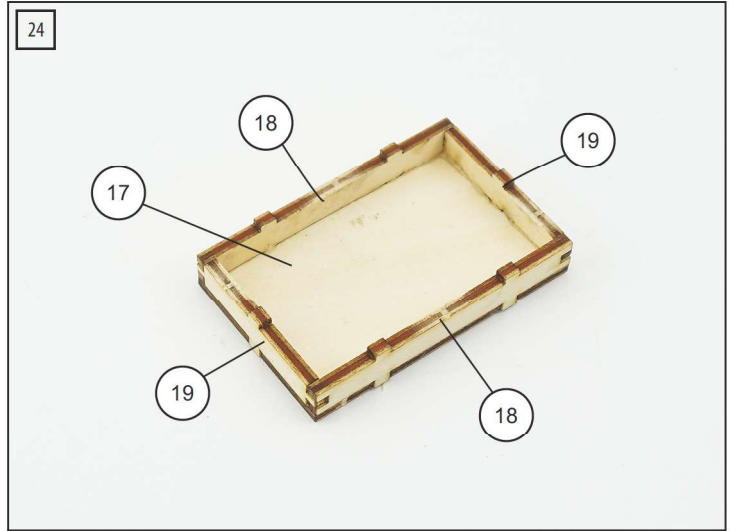
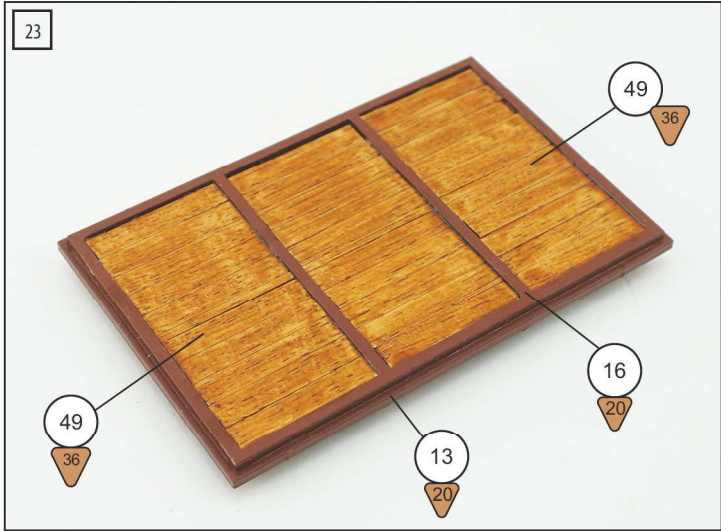
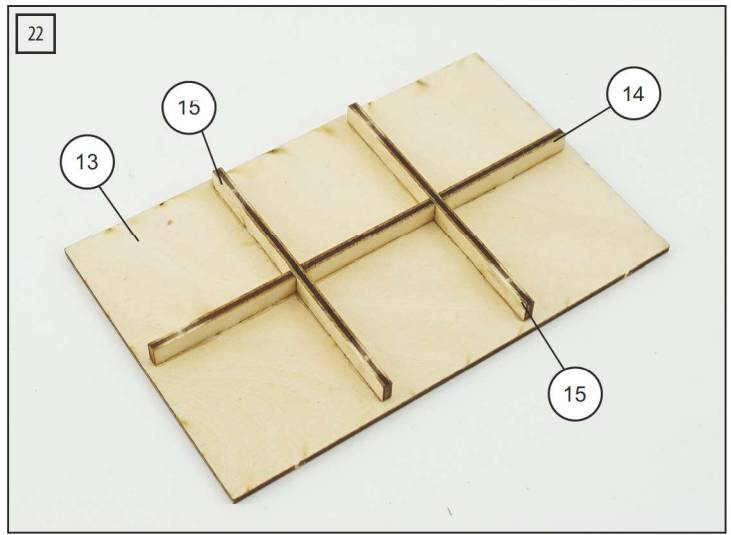
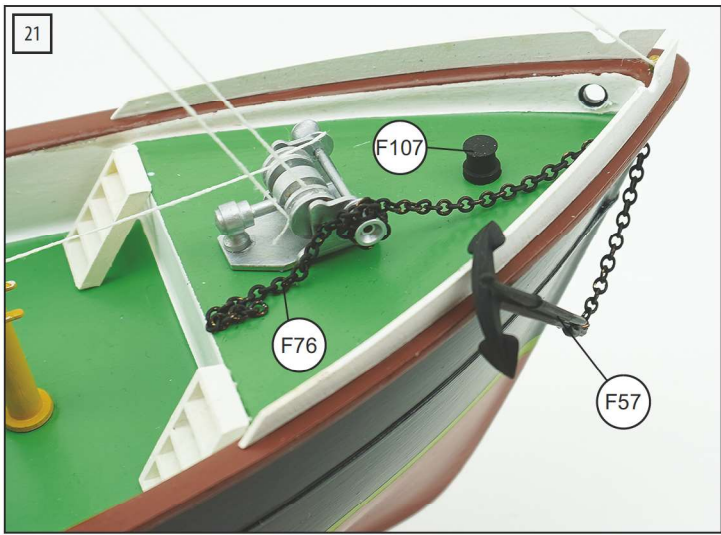
Billing 1 = White
 Billing 6 = Hull Red
 Billing 7 = Sea Blue
 Billing 11 = Black
 Billing 13 = Trainer Yellow
 Billing 15 = Silver
 Billing 16 = Gold
 Billing 20 = Satin Brown
 Billing 32 = Lime
 Billing 35 = Signal Red
 Billing 36 = Wood stain

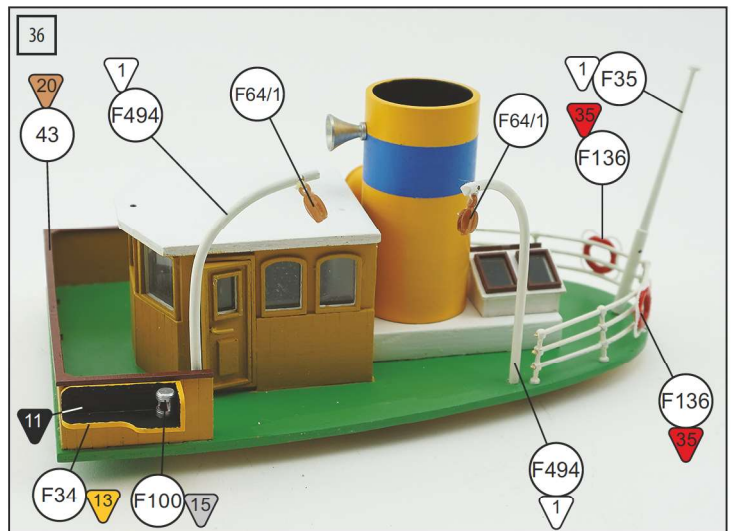
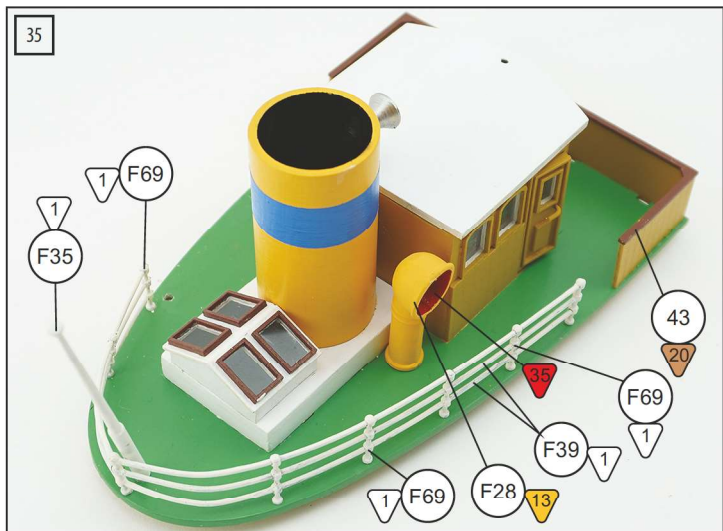
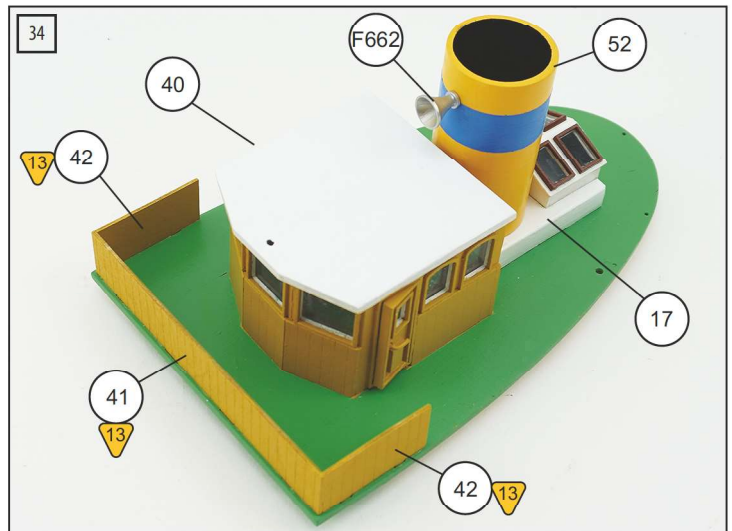
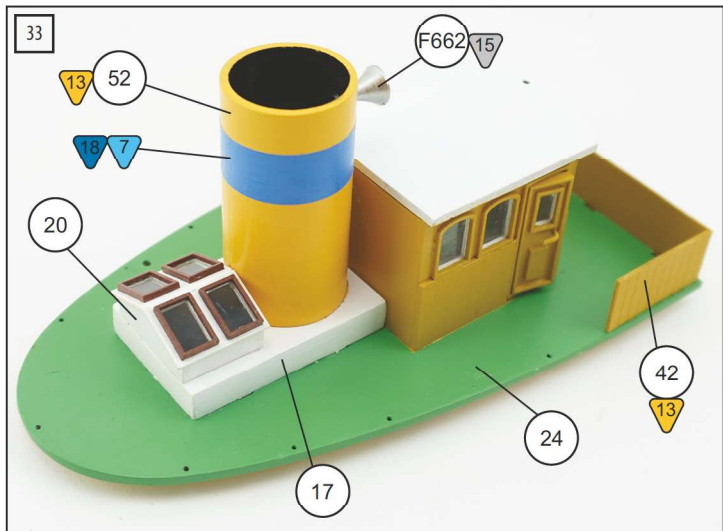
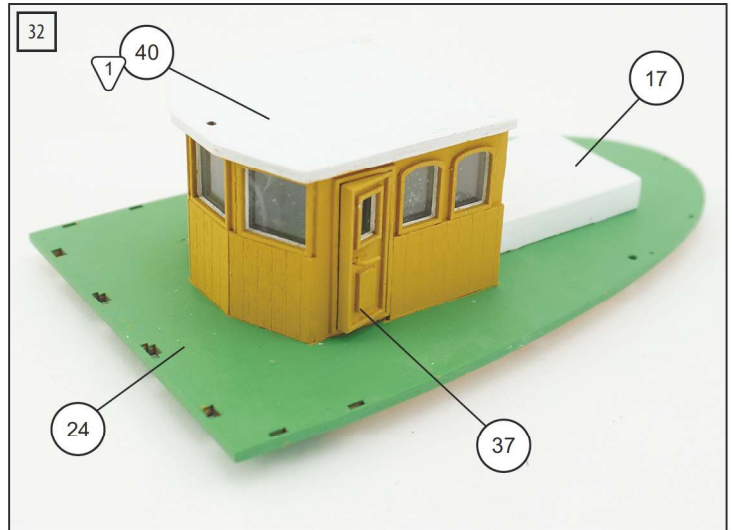
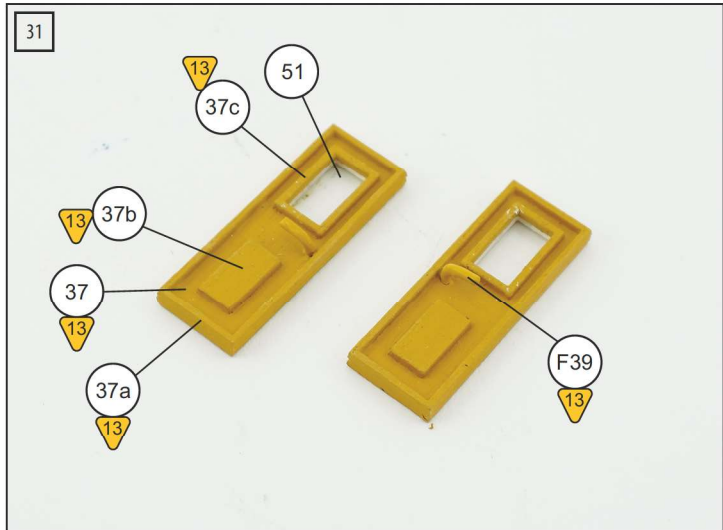
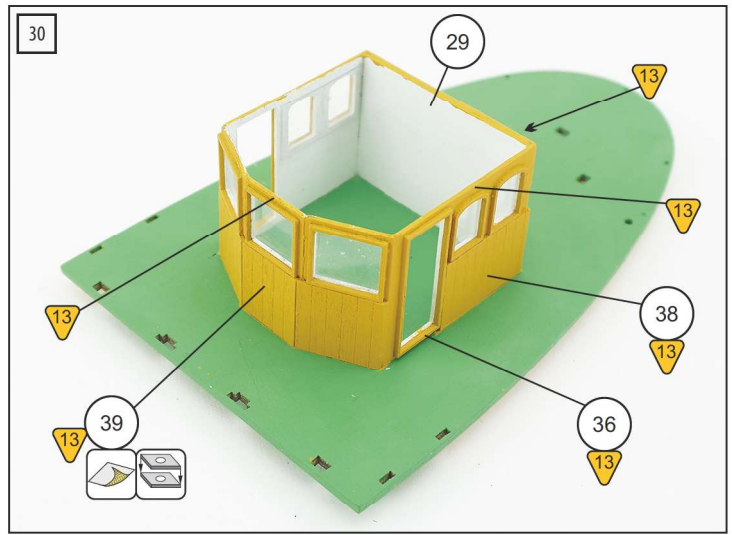
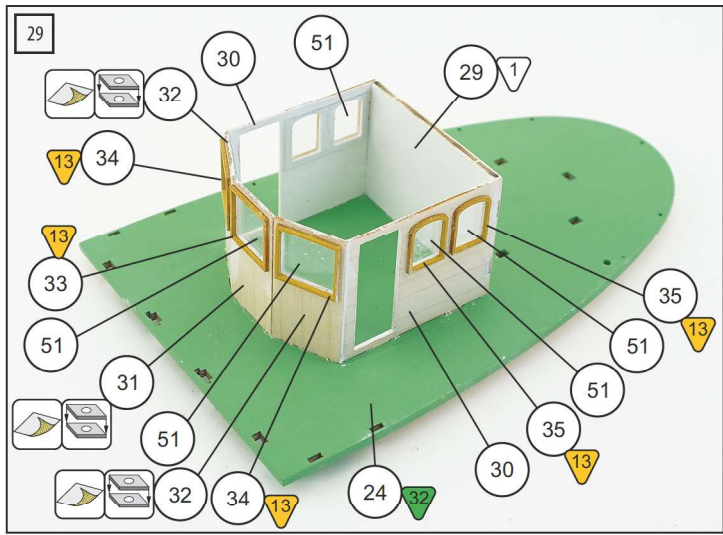
	Part number		Cut out		Paint with primer paint
	Paint number (* alternative colour)		Use putty (fill and sand)		Use cyanoacrylate glue
	Wood stain		Fit to other parts		Give shape (before sticking)
	Rope number		Part made with layers		Give shape (before sticking, if necessary use water)
	Give shape (for example use sand paper)		Drill a hole (x mm)		Roll up

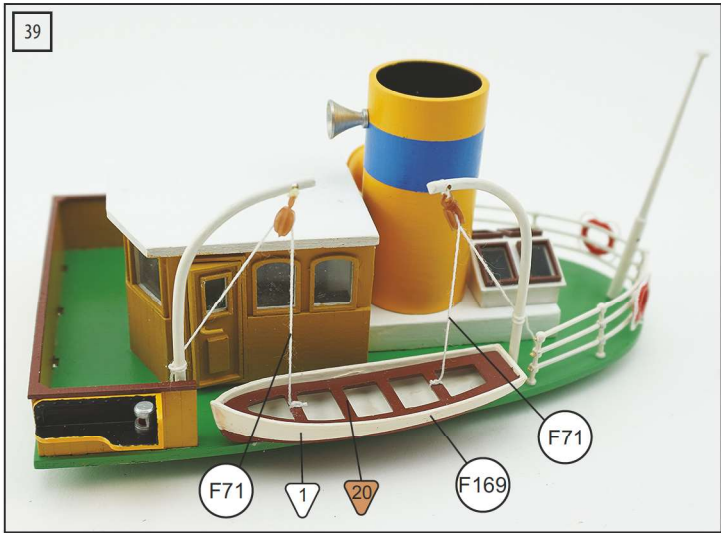
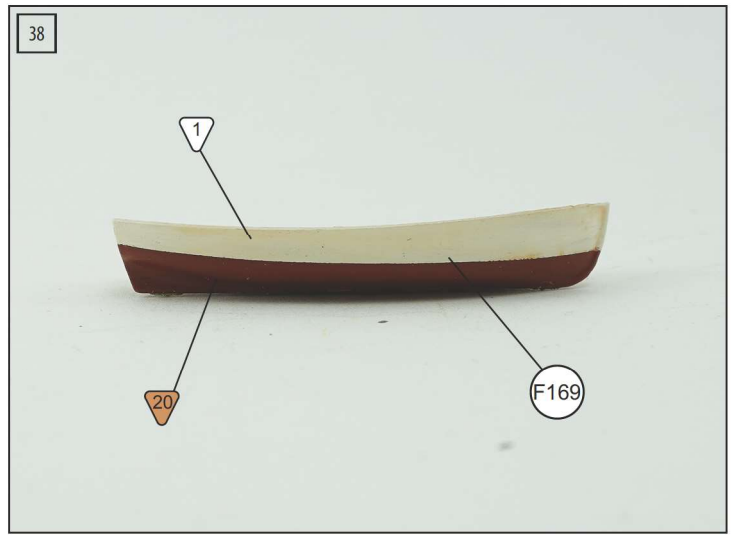
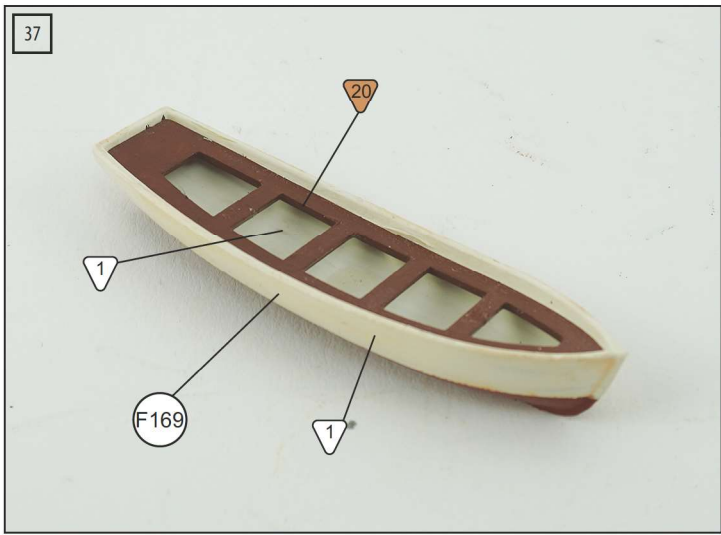


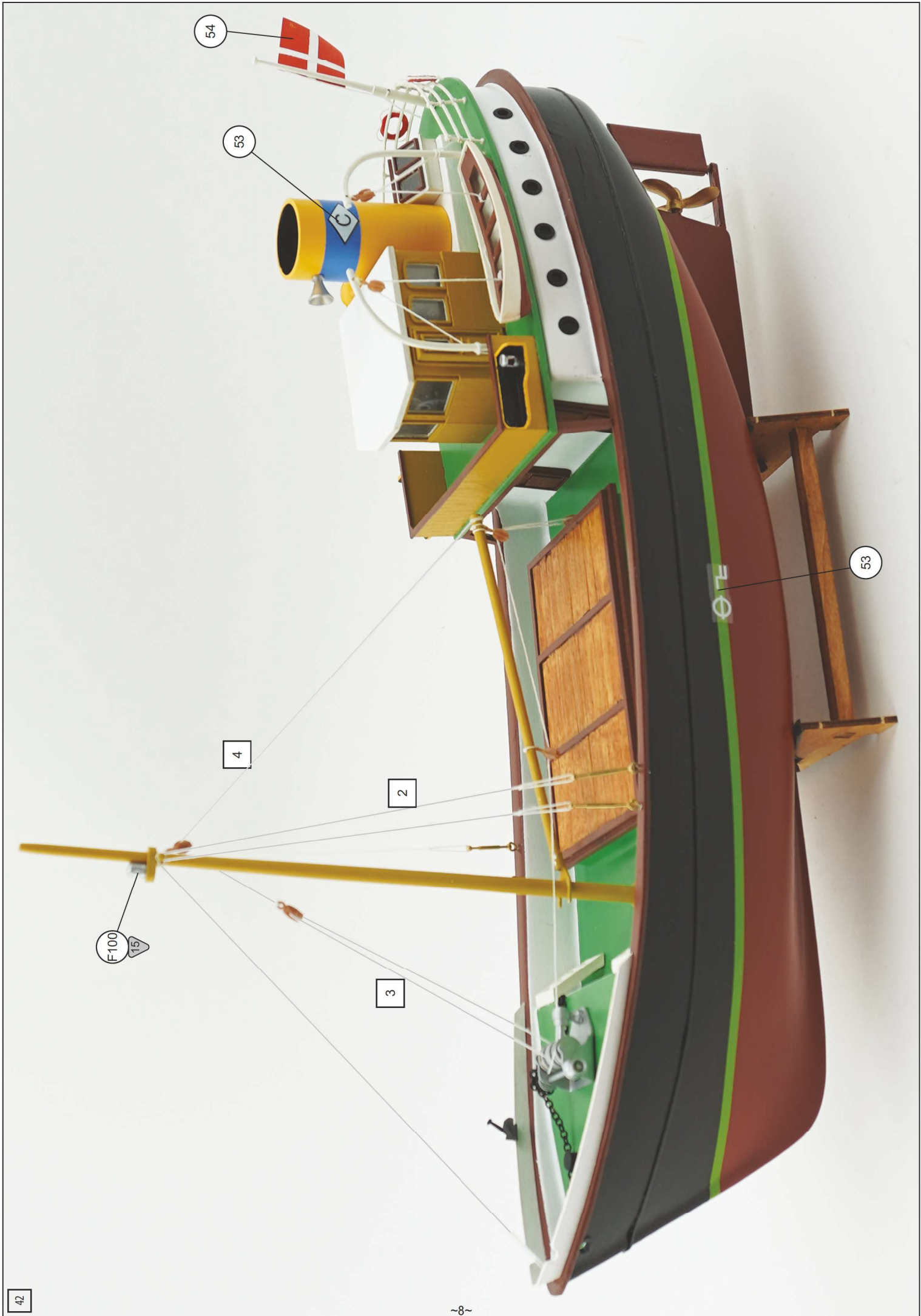












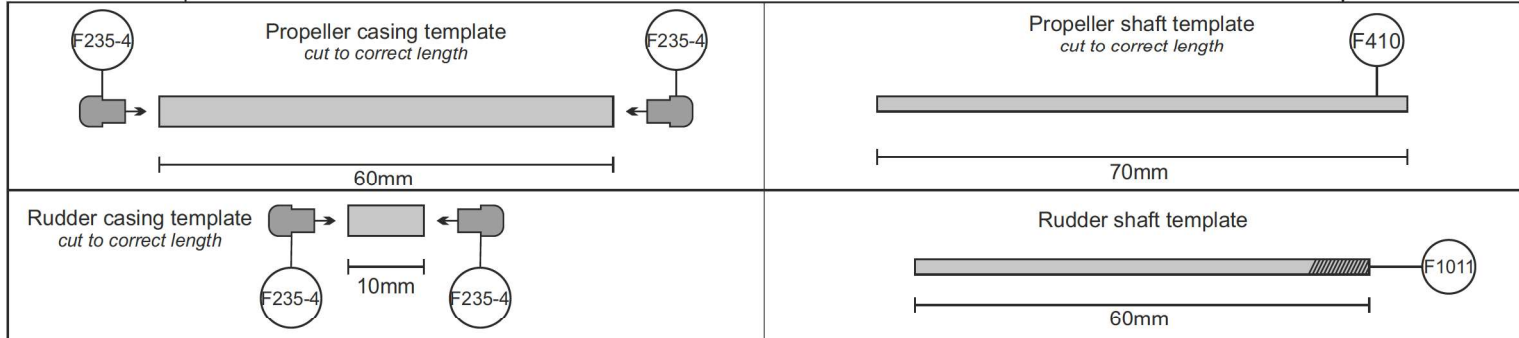
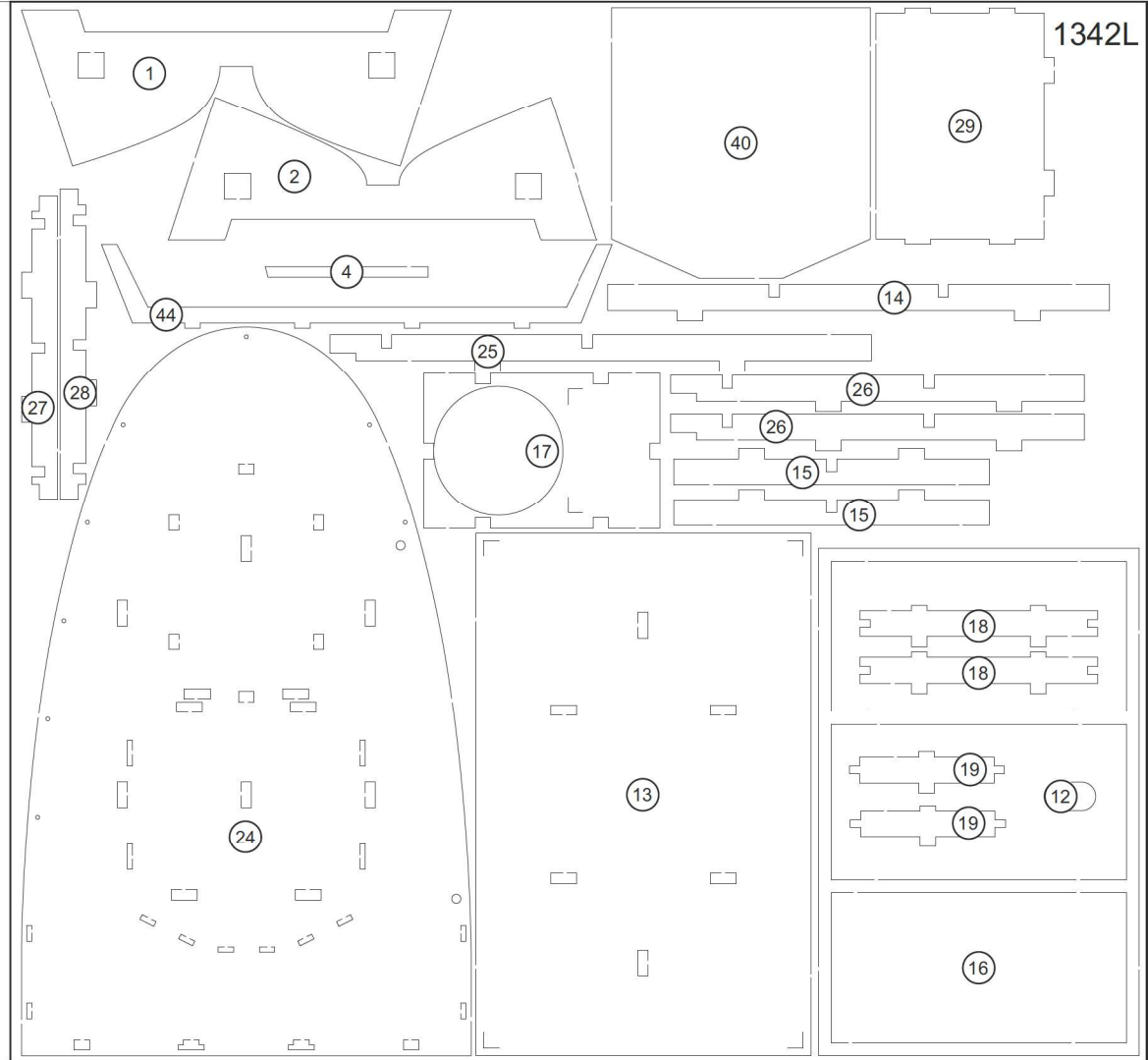
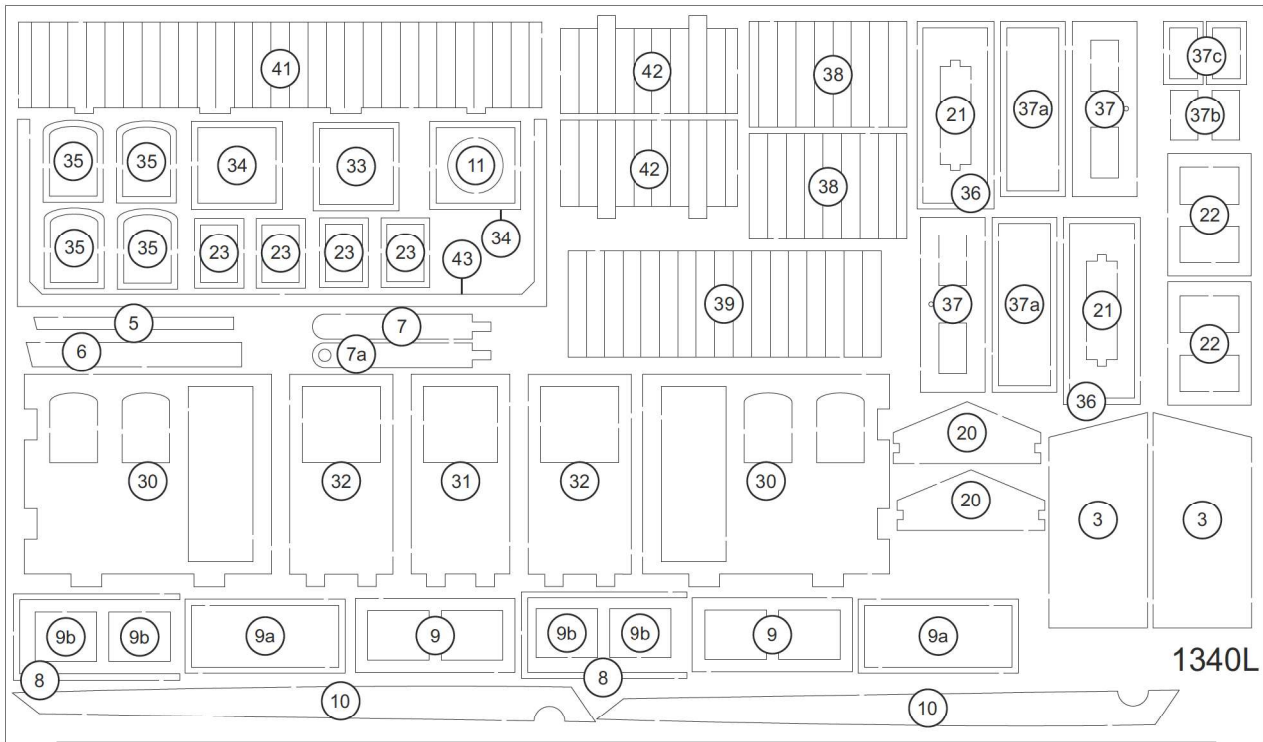


Table of contents for CARLI Art. No. 236

Pes.	No.	Dimension	Material	Found in	DK	GB	D	F	NL
1	1	2 mm x-veneér	1342L		Sokkel	Base	Sokkel	Socle	Sokkel
1	2	2 mm x-veneér	1342L		Sokkel	Base	Sokkel	Socle	Sokkel
2	3	1 mm x-veneér	1340L		Ror	Rudder	Ruder	Gouvernail	Roer
1	4	2 mm x-veneér	1342L		Ror	Rudder	Ruder	Gouvernail	Roer
2	5-6	1 mm x-veneér	1340L		Ror	Rudder	Ruder	Gouvernail	Roer
2	7-7a	1 mm x-veneér	1340L		Ror	Rudder	Ruder	Gouvernail	Roer
2	8	1 mm x-veneér	1340L		Ror	Rudder	Ruder	Gouvernail	Roer
8	9-9b	1 mm x-veneér	1340L		Dør	Door	Tür	Porte	Deur
2	10	1 mm x-veneér	1340L		Skrog	Hull	Rumpf	Coque	Romp
1	11	1 mm x-veneér	1340L		Mast	Mast	Mast	Mât	Mast
1	12	2 mm x-veneér	1342L		Støtte	Support	Stütze	Support	Steun
1	13	2 mm x-veneér	1342L		Sokkel	Base	Sokkel	Socle	Sokkel
1	14	2 mm x-veneér	1342L		Støtte	Support	Stütze	Support	Steun
2	15	2 mm x-veneér	1342L		Støtte	Support	Stütze	Support	Steun
1	16	2 mm x-veneér	1342L		Skylight	Hatch	Oberlicht	Claire-voie	Bovenlicht
1	17	2 mm x-veneér	1342L		Sokkel	Base	Sokkel	Socle	Sokkel
2	18	2 mm x-veneér	1342L		Sokkel	Base	Sokkel	Socle	Sokkel
2	19	2 mm x-veneér	1342L		Sokkel	Base	Sokkel	Socle	Sokkel
2	20	1 mm x-veneér	1340L		Skylight	Skylight	Oberlicht	Claire-voie	Bovenlicht
2	21	1 mm x-veneér	1340L		Skylight	Skylight	Oberlicht	Claire-voie	Bovenlicht
2	22	1 mm x-veneér	1340L		Skylight	Skylight	Oberlicht	Claire-voie	Bovenlicht
4	23	1 mm x-veneér	1340L		Skylight	Skylight	Oberlicht	Claire-voie	Bovenlicht
1	24	2 mm x-veneér	1342L		Daek	Deck	Deck	Pont	Dek
1	25	2 mm x-veneér	1342L		Støtte	Support	Stütze	Support	Steun
2	26	2 mm x-veneér	1342L		Støtte	Support	Stütze	Support	Steun
1	27	2 mm x-veneér	1342L		Støtte	Support	Stütze	Support	Steun
1	28	2 mm x-veneér	1342L		Støtte	Support	Stütze	Support	Steun
1	29	2 mm x-veneér	1342L		Kahyt	Cabin	Kajüte	Cabine	Kajuit
2	30	1 mm x-veneér	1340L		Kahyt	Cabin	Kajüte	Cabine	Kajuit
1	31	1 mm x-veneér	1340L		Kahyt	Cabin	Kajüte	Cabine	Kajuit
2	32	1 mm x-veneér	1340L		Kahyt	Cabin	Kajüte	Cabine	Kajuit
1	33	1 mm x-veneér	1340L		Vindue	Window	Fenster	Fenêtre	Raam
2	34	1 mm x-veneér	1340L		Vindue	Window	Fenster	Fenêtre	Raam
4	35	1 mm x-veneér	1340L		Vindue	Window	Fenster	Fenêtre	Raam
2	36	1 mm x-veneér	1340L		Dør	Door	Tür	Porte	Deur
8	37-37c	1 mm x-veneér	1340L		Dør	Door	Tür	Porte	Deur
2	38	1 mm x-veneér	1340L		Beklædning	Sheathing	Ummanteln	Revêtement	Moord
1	39	1 mm x-veneér	1340L		Beklædning	Sheathing	Ummanteln	Revêtement	Moord

Table of contents for CARLI Art. No. 236

Pes.	No.	Dimension	Material	Found in	DK	GB	D	F	NL
1	40	2 mm x-veneér	1342L		Kahyt	Cabin	Kajüte	Cabine	Kajuit
1	41	1 mm x-veneér	1340L		Væg	Wall	Wand	Mur	Muur
2	42	1 mm x-veneér	1340L		Væg	Wall	Wand	Mur	Muur
1	43	1 mm x-veneér	1340L		Væg	Wall	Wand	Mur	Muur
1	44	2 mm x-veneér	1342L		Støtte	Support	Stütze	Support	Steun
1	45	5x5x300mm	Basswood	TS	Sokkel	Base	Sokkel	Socle	Sokkel
1	46	ø4x60mm	Brass	TS	Propelaksel	Propeller shaft	Stevenrohr	Arbre porte hélice	Schroefas
1	47	ø4x180mm	Basswood	TS	Mast	Mast	Mast	Mât	Mast
1	48	ø3x120mm	Basswood	TS	Mast	Mast	Mast	Mât	Mast
3	49	1,7x6x350mm	Wood	TS	Lister	Strip	Leisten	Baguettes	Strips
4	50	0,7x2x250mm	Annegré	TS	Lister	Strip	Leisten	Baguettes	Strips
1	51	50x30mm	Plastic	VEJ	Vindue	Window	Fenster	Fenêtre	Raam
1	52	ø25x68mm	PVC	FS	Skorsten	Chimney	Schornstein	Cheminée	Schoorsteen
1	53		Sticker	VEJ	Transfer	Transfer	Abziehbild	Decalcomanies	Transfer
1	54		Flag	VEJ	Flag	Flag	Flagge	Drapeau	Vlag
1	P25		Plastic		Skrog	Hull	Rumpf	Coque	Romp
1	P29		Plastic		Daek	Deck	Deck	Pont	Dek
1		A4		VEJ	Byggevejledning	Building instruction	Bauanleitung	Instruction de montage	Bouwbeschrijving
1		A3		VEJ	Tegning	Drawing	Zeichnung	Plan	Tekening
1	F28	ø7x33mm	Plastic	FS	Ventil	Vent	Lüfter	Marche á air	Luchtoker
2	F34	23mm	Plastic	FS	Lys	Light	Licht	Feux	Licht
1	F35	ø3x61mm	Brass	FS	Flagstang	Flagstaff	Flaggenstock	Hampe	Vlaggestok
3	F39	ø1x250mm	Brass	TS	Messingtråd	Wire	Messingdraht	Fil de laiton	Messingdraad
1	F45	24,5mm	Plastic	FS	Skitsskrue	Propeller	Schiffsschraube	Hélice	Propeller
1	F57	35mm	Plastic	FS	Anker	Anchor	Anker	Ancre	Anker
7	F64/1	5mm	Plastic	FS	Blokke	Block	Blokke	Poulie	Blokken
14	F67	ø5mm	Plastic	FS	Kooje	Portlight	Bullauge	Hublot	Patrijspoort
8	F69	15mm	Brass	FS	Gelænderstøtte	Rail stanchion	Relingsstütze	Chandelier	Railingpaal
1	F71	3m	Rope	TS	Ræb	Rope	Seil	Cordage	Touw
1	F76	ø2,5x150mm	Metal	TS	Kæde	Chain	Kette	Chaîne	Ketting
3	F100	ø4x5mm	Brass	FS	Lys	Light	Licht	Feux	Licht
1	F107	ø6x6mm	Brass	FS	Kapstan	Capstan	Kapstan	Cabestan	Kaapstander
1	F134		Brass	FS	Spil	Winch	Winde	Treuil	Winch
2	F136	12x12mm	Plastic	FS	Redningskrans	Lifering	Rettingsring	Ceinture sauvetage	Reddingsboei
1	F169	64x20x11mm	Plastic	FS	Redningsbåd	Lifeboat	Rettingsboot	Canot de sauvetage	Reddingsboot
1	F181	13x60mm	Plastic	FS	Lejder	Ladder	Leiter	Echelle	Ladder
4	F235-4	ø4x6mm	Brass	FS	Bøsning	Bushing	Buchsen	Baque	Busje
4	F285	ø2x6mm	Brass	FS	Øjenbolt	Eyebolt	Ringschraube	Anneau à visser	Oogbout

Table of contents for CARLI Art. No. 236

Pes.	No.	Dimension	Material	Found in	DK	GB	D	F	NL
1	F410	ø2x250mm	Brass	TS	Propelaksel	Propeller shaft	Stevenrohr	Arbre porte hélice	Schroefas
4	F447	ø2x18mm	Brass	FS	Vantiskrue	Rigging screw	Wantenschraube	Vis de ridage	Wantspanner
1	F456	9x17,5mm	Metal	FS	Gaffel	Gaff	Gaffel	Corne	Gaffel
2	F494	ø2x55mm	Brass	FS	David	David	David	Bossoir	David
1	F662	ø8x10,5mm	Brass	FS	Sirene	Siren	Sirene	Sirène	Sirene
1	F1011	ø2x60mm	Brass	TS	Ror skaft	Rudder shaft	Ruderwelle	Arbre du gouvernail	Roeras

Table of contents for CARLI Art. No. 236

Pes.	No.	Dimension	Material	Found in	E	I	P	PL
1	1	2 mm x-veneér	1342L		Base	Base	Base	Podstawa
1	2	2 mm x-veneér	1342L		Base	Base	Base	Podstawa
2	3	1 mm x-veneér	1340L		Timón	Timone	Leme	Ster
1	4	2 mm x-veneér	1342L		Timón	Timone	Leme	Ster
2	5-6	1 mm x-veneér	1340L		Timón	Timone	Leme	Ster
2	7-7a	1 mm x-veneér	1340L		Timón	Timone	Leme	Ster
2	8	1 mm x-veneér	1340L		Timón	Timone	Leme	Ster
8	9-9b	1 mm x-veneér	1340L		Puerta	Porta	Porta	Drzwi
2	10	1 mm x-veneér	1340L		Casco	Scafo	Casco	Kadłub
1	11	1 mm x-veneér	1340L		Palo	Albero	Mastro	Maszt
1	12	2 mm x-veneér	1342L		Soporte	Supporto	Supporte	Wspornik
1	13	2 mm x-veneér	1342L		Base	Base	Base	Podstawa
1	14	2 mm x-veneér	1342L		Soporte	Supporto	Supporte	Wspornik
2	15	2 mm x-veneér	1342L		Soporte	Supporto	Supporte	Wspornik
1	16	2 mm x-veneér	1342L		Claraboya	Osteriggio	Clarabóia	Światlik
1	17	2 mm x-veneér	1342L		Base	Base	Base	Podstawa
2	18	2 mm x-veneér	1342L		Base	Base	Base	Podstawa
2	19	2 mm x-veneér	1342L		Base	Base	Base	Podstawa
2	20	1 mm x-veneér	1340L		Claraboya	Osteriggio	Clarabóia	Światlik
2	21	1 mm x-veneér	1340L		Claraboya	Osteriggio	Clarabóia	Światlik
2	22	1 mm x-veneér	1340L		Claraboya	Osteriggio	Clarabóia	Światlik
4	23	1 mm x-veneér	1340L		Claraboya	Osteriggio	Clarabóia	Światlik
1	24	2 mm x-veneér	1342L		Cubierta	Ponte	Convés	Pokład
1	25	2 mm x-veneér	1342L		Soporte	Supporto	Supporte	Wspornik
2	26	2 mm x-veneér	1342L		Soporte	Supporto	Supporte	Wspornik
1	27	2 mm x-veneér	1342L		Soporte	Supporto	Supporte	Wspornik
1	28	2 mm x-veneér	1342L		Soporte	Supporto	Supporte	Wspornik
1	29	2 mm x-veneér	1342L		Camarote	Cabina	Cabine	Kabina
2	30	1 mm x-veneér	1340L		Camarote	Cabina	Cabine	Kabina

Table of contents for CARLI Art. No. 236

Pes.	No.	Dimension	Material	Found in	E	I	P	PL
1	31	1 mm x-veneér	1340L		Camarote	Cabina	Cabine	Kabina
2	32	1 mm x-veneér	1340L		Camarote	Cabina	Cabine	Kabina
1	33	1 mm x-veneér	1340L		Ventana	Finestra	Janela	Okno
2	34	1 mm x-veneér	1340L		Ventana	Finestra	Janela	Okno
4	35	1 mm x-veneér	1340L		Ventana	Finestra	Janela	Okno
2	36	1 mm x-veneér	1340L		Puerta	Porta	Porta	Drzwi
8	37-37c	1 mm x-veneér	1340L		Puerta	Porta	Porta	Drzwi
2	38	1 mm x-veneér	1340L		Revestimiento	Guaina	Revestimento	Poszycie
1	39	1 mm x-veneér	1340L		Revestimiento	Guaina	Revestimento	Poszycie
1	40	2 mm x-veneér	1342L		Camarote	Cabina	Cabine	Kabina
1	41	1 mm x-veneér	1340L		Muro	Parete	Parede	Ściana
2	42	1 mm x-veneér	1340L		Muro	Parete	Parede	Ściana
1	43	1 mm x-veneér	1340L		Muro	Parete	Parede	Ściana
1	44	2 mm x-veneér	1342L		Soporte	Supporto	Suporte	Wspornik
1	45	5x5x200mm	Basswood	TS	Base	Base	Base	Podstawa
1	46	ø2x60mm	Brass	TS	Je de hélice	Albero porta-elica	Eixo da hélice	Wał
1	47	ø4x180mm	Basswood	TS	Palo	Albero	Mastro	Maszt
1	48	ø3x120mm	Basswood	TS	Palo	Albero	Mastro	Maszt
3	49	1,7x6x350mm	Wood	TS	Listón	Listello	Tiras	Listwa
4	50	0,7x2x250mm	Annegré	TS	Listón	Listello	Tiras	Listwa
1	51	50x30mm	Plastic	VEJ	Ventana	Finestra	Janela	Okno
1	52	ø25x68mm	PVC	FS	Chimenea	Ciminiera	Chaminé	Komin
1	53		Sticker	VEJ	Calcas	Decalcomania	Decalque	Kalkomania
1	54		Flag	VEJ	Bandera	Bandiera	Bandeira	Flaga
1	P25		Plastic		Casco	Scafo	Casco	Kadhub
1	P29		Plastic		Cubierta	Ponte	Convés	Pokład
1				VEJ	Instrucciones de montaje	Istruzioni di montaggio	Instruções de montagem	Instrukcja budowy
1		A4		VEJ	El dibujo	Disegno	Desenho	Rysunek główny
1	F28	ø7x33mm	Plastic	FS	Respiradero	Valvola	Respiradouro	Wentylacja
2	F34	23mm	Plastic	FS	Luz	Leggero	Luzes	Lampa
1	F35	ø3x61mm	Brass	FS	Asta de bandera	Asia portabandiera	Mastro de bandeira	Maszt flagowy
3	F39	ø1x250mm	Brass	TS	Hilo de latón	Brasswire	Fio de latão	Drut
1	F45	24,5mm	Plastic	FS	Hélice	Elica	Hélice	Śruba
1	F57	35mm	Plastic	FS	Ancla	Ancora	Âncora	Kotwica
7	F64/1	5mm	Plastic	FS	Bloques	Bitta	Blocos	Blok
14	F67	ø5mm	Plastic	FS	Portilla	Oblò	Luz de bombordo	Iluminator
8	F69	15mm	Brass	FS	Soporte de pasamanos	Supporti per corrimano	Poste de trilhò	Reling
1	F71	3m	Rope	TS	Soga	Corda	Corda	Lina

Table of contents for CARLI Art. No. 236

Pes.	No.	Dimension	Material	Found in	E	I	P	PL
1	F76	ø2,5x150mm	Metal	TS	Cadena	Catena	Corrente	Łańcuch
3	F100	ø4x5mm	Brass	FS	Luz	Leggero	Luzes	Lampa
1	F107	ø6x6mm	Brass	FS	Cabrestante	Argano	Cabrestante	Kabestan
1	F134		Brass	FS	Chigre	Verricello, Arganello	Guincho	Wciagarka
2	F136	12x12mm	Plastic	FS	Cinturones salvavidas	Scialuppa da salvataggio	Bote salv-vida	Kolo ratunkowe
1	F169	64x20x11mm	Plastic	FS	Bote salvavidas	Battello di salvataggio	Barco salva-vidas	Szalupa
1	F181	13x60mm	Plastic	FS	Escalera	Scaletta	Escada	Drabina
4	F235-4	ø4x6mm	Brass	FS	Casquillo	Boccola	Casquilho	Tuleja
4	F285	ø2x6mm	Brass	FS	Cáncamo	Occhio	Olhal	Śruba oczkowa
1	F410	ø2x250mm	Brass	TS	Je de hélice	Albero porta-elica	Eixo da hélice	Wał
4	F447	ø2x18mm	Brass	FS	Tensor de obenques	Vite sarte	Parafuso do cordame	Śruba
1	F456	9x17,5mm	Metal	FS	Pico de cangrejo	Raffia	Carangueja	Gafel
2	F494	ø2x55mm	Brass	FS	Pescante	Gruetta	Serviola	Szłupbelka
1	F662	ø8x10,5mm	Brass	FS	Sirena	Sirena	Sirene	Syrena
1	F1011	ø2x60mm	Brass	TS	Eje del timón	Albero di timone	Eixo do leme	Wał



Billing Boats

www.billingboats.com
service@billingboats.dk